

---

*Comfort-Aire*®

**Century**

---

**Service Manual**

**VMH-SV Series**

**Multi Zone Mini-Split**

**Model**

A-VMH18DV-1, A-VMH28TV-1, A-VMH36QV-1,  
A-VMH48PV-1

# CONTENTS

<b>1. Indoor Unit Combination</b> .....	3
<b>2. Dimension Of Outdoor Unit</b> .....	6
<b>3. Refrigerant Cycle Diagram</b> .....	8
<b>4. Installation Details</b> .....	10
4.1 Wrench torque sheet for installation .....	10
4.2 Connecting the cables .....	10
4.3 Pipe length and the elevation .....	10
4.4 First-Time Installation .....	10
4.5 Adding Refrigerant after Long-Term System Operation .....	12
4.6 Procedure when servicing the indoor unit refrigeration circuit .....	12
4.7 Evacuation after servicing the outdoor unit refrigeration circuit .....	13
<b>5. Electronic Function</b> .....	15
5.1 Abbreviation .....	15
5.2 Electric Control Working Environment .....	15
5.3 Main Protection .....	15
5.4 Control and Functions .....	17
<b>6. Wiring Diagrams</b> .....	23
<b>7. Troubleshooting</b> .....	34
7.1 Safety .....	34
7.2 Indoor Unit Error Display .....	35
7.3 Outdoor Unit Display .....	38
7.4 Diagnosis and Solution .....	46
7.5 Trouble Criterion of Main Parts .....	105
<b>8. Disassembly Instructions</b> .....	115
<b>18DV-1 28TV-1 (WD30 metal plate)</b> .....	115
<b>36QV-1, 48PV-1 (WE30 metal plate)</b> .....	124

## 1. Indoor Unit Combination

Multi DC Outdoor Unit	Nominal capacity	Suggested Combination	Limit
18DV-1	5.2kW	6+6	None
		6+9	
		6+12	
		6+18	
		9+9	
		9+12	
		12+12	

Multi DC Outdoor Unit	Nominal capacity	Suggested Combination			Limit
		Two units	Three units		
28TV--1	7.8kW	6+12	6+6+6	6+9+18	None
		6+18	6+6+9	6+12+12	
		9+9	6+6+12	9+9+9	
		9+12	6+6+18	9+9+12	
		9+18	6+6+24	9+9+18	
		9+24	6+9+9	9+12+12	
		12+12	6+9+12	12+12+12	
		12+18			
		12+24			
		18+18			

Multi DC Outdoor Unit	Nominal capacity	Suggested Combination					Limit
		Two units	Three units		Four units		
36QV-1	10.5kW	6+18	6+6+12	9+9+9	6+6+6+6	6+9+9+12	None
		6+24	6+6+18	9+9+12	6+6+6+9	6+9+9+18	
		6+30	6+6+24	9+9+18	6+6+6+12	6+9+9+24	
		9+18	6+6+30	9+9+24	6+6+6+18	6+9+12+12	
		9+24	6+9+12	9+9+30	6+6+6+24	6+9+12+18	
		9+30	6+9+18	9+12+12	6+6+6+30	6+12+12+12	
		12+12	6+9+24	9+12+18	6+6+9+9	6+12+12+18	
		12+18	6+9+30	9+12+24	6+6+9+12	9+9+9+9	
		12+24	6+12+12	9+18+18	6+6+9+18	9+9+9+12	
		12+30	6+12+18	12+12+12	6+6+9+24	9+9+9+18	
		18+18	6+12+24	12+12+18	6+6+12+12	9+9+12+12	
		18+24	6+12+30	12+12+24	6+6+12+18	9+9+12+18	
		18+30	6+18+18	12+18+18	6+6+12+24	9+12+12+12	
		24+24	6+18+24		6+9+9+9	12+12+12+12	

Multi DC Outdoor Unit	Nominal capacity	Suggested Combination						Limit	
		Two units	Three units		Four units		Five units		
48PV-1	14kW	9+24	6+6+24	9+12+18	6+6+6+18	6+9+18+30	6+6+6+6+9	6+6+12+12+12	None
		9+30	6+6+30	9+12+24	6+6+6+24	6+12+12+12	6+6+6+6+12	6+6+12+12+18	
		9+36	6+6+36	9+12+30	6+6+6+30	6+12+12+18	6+6+6+6+18	6+6+12+12+24	
		12+24	6+9+24	9+12+36	6+6+6+36	6+12+12+24	6+6+6+6+24	6+6+12+18+18	
		12+30	6+9+30	9+18+18	6+6+9+18	6+12+12+30	6+6+6+6+30	6+9+9+9+9	
		12+36	6+9+36	9+18+24	6+6+9+24	6+12+18+18	6+6+6+6+36	6+9+9+9+12	
		18+18	6+12+18	9+18+30	6+6+9+30	6+12+18+24	6+6+6+9+9	6+9+9+9+18	
		18+24	6+12+24	9+18+36	6+6+9+36	9+9+9+9	6+6+6+9+12	6+9+9+9+24	
		18+30	6+12+30	9+24+24	6+6+12+12	9+9+9+12	6+6+6+9+18	6+9+9+9+30	
		18+36	6+12+36	9+24+30	6+6+12+18	9+9+9+18	6+6+6+9+24	6+9+9+12+12	
		24+30	6+18+18	12+12+12	6+6+12+24	9+9+9+24	6+6+6+9+30	6+9+9+12+18	
		24+36	6+18+24	12+12+18	6+6+12+30	9+9+9+30	6+6+6+9+36	6+9+9+12+24	
		30+30	6+18+30	12+12+24	6+6+12+36	9+9+9+36	6+6+6+12+12	6+9+9+18+18	
			6+18+36	12+12+30	6+6+18+18	9+9+12+12	6+6+6+12+18	6+9+12+12+12	
			6+24+24	12+12+36	6+6+18+24	9+9+12+18	6+6+6+12+24	6+9+12+12+18	
			6+24+30	12+18+18	6+6+18+30	9+9+12+24	6+6+6+12+30	6+9+12+12+24	
			9+9+18	12+18+24	6+6+24+24	9+9+12+30	6+6+6+18+18	6+12+12+12+12	
			9+9+24	12+18+30	6+9+9+12	9+9+18+18	6+6+6+18+24	6+12+12+12+18	
			9+9+30	12+24+24	6+9+9+18	9+9+18+24	6+6+9+9+9	9+9+9+9+9	
			9+9+36	18+18+18	6+9+9+24	9+12+12+12	6+6+9+9+12	9+9+9+9+12	
			9+12+12	18+18+24	6+9+9+30	9+12+12+18	6+6+9+9+18	9+9+9+9+18	
					6+9+9+36	9+12+12+24	6+6+9+9+24	9+9+9+9+24	
					6+9+12+12	9+12+12+30	6+6+9+9+30	9+9+9+12+12	
					6+9+12+18	9+12+18+18	6+6+9+12+12	9+9+9+12+18	
					6+9+12+24	9+12+18+24	6+6+9+12+18	9+9+9+12+24	
					6+9+12+30	12+12+12+12	6+6+9+12+24	9+9+12+12+12	
					6+9+12+36	12+12+12+18	6+6+9+12+30	9+9+12+12+18	
					6+9+18+18	12+12+12+24	6+6+9+18+18	9+12+12+12+12	
			6+9+18+24	12+12+18+18	6+6+9+18+24	12+12+12+12+12			

## 2. Dimension Of Outdoor Unit

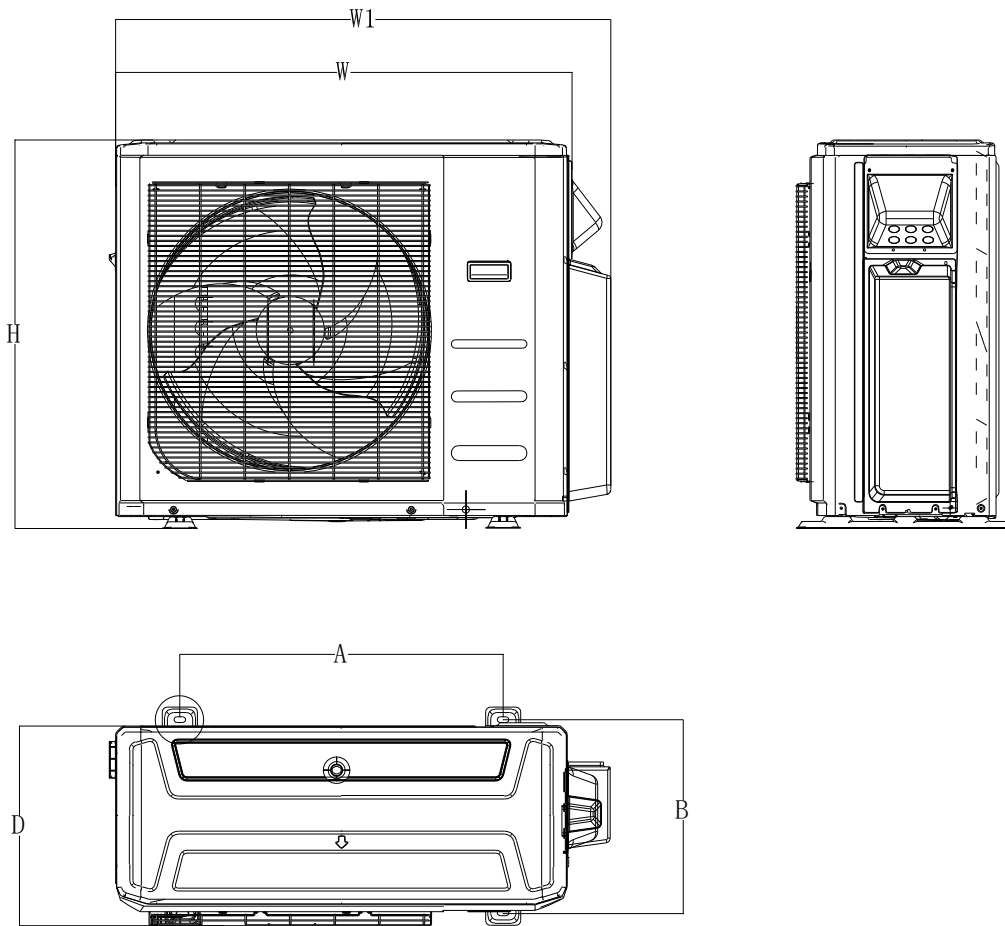

Model	Unit	W	D	H	W1	A	B
18DV-1	mm	890	342	673	990	663	354
	inch	35.04	13.46	26.50	38.98	26.10	13.94
28TV-1	mm	946	410	810	1034	673	403
	inch	37.2	16.5	31.9	40.6	26.5	15.9

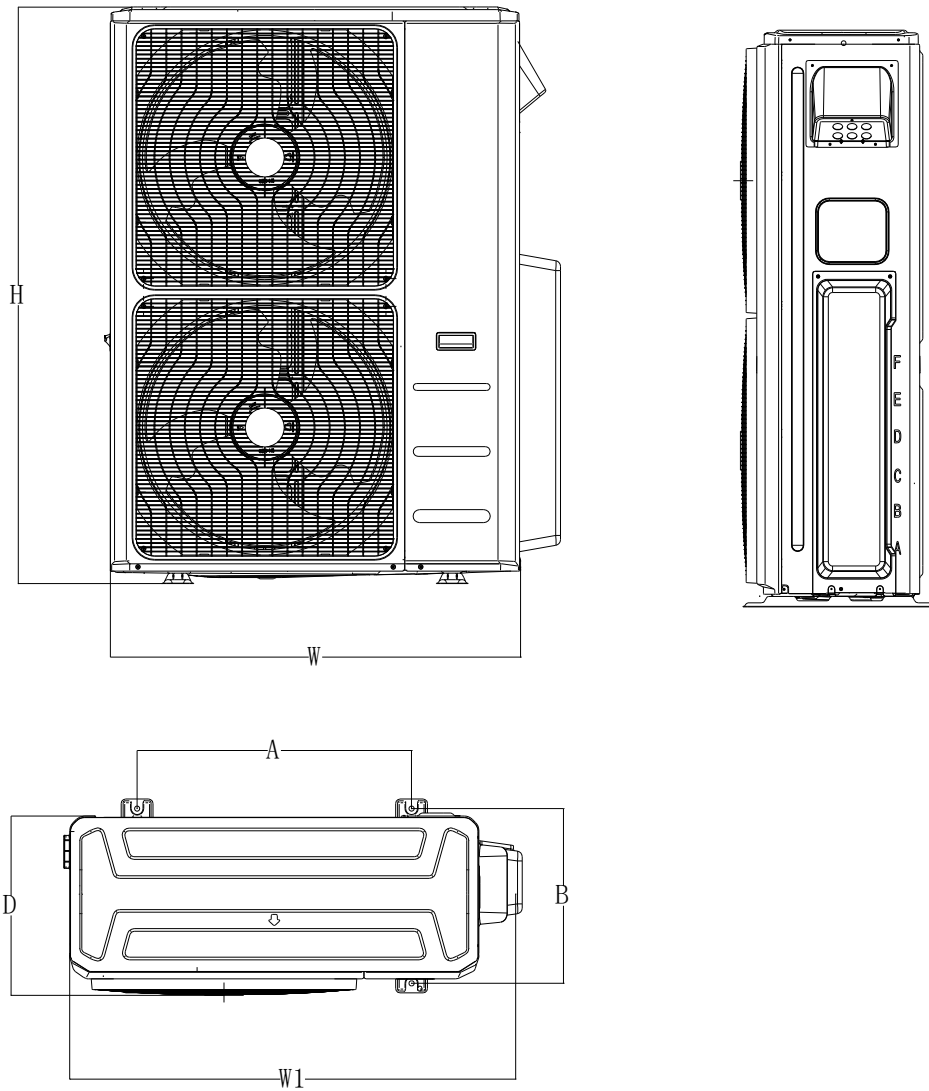

Model	Unit	W	D	H	W1	A	B
36QV-1 48PV-1	mm	952	415	1333	1060	634	404
	inch	37.5	16.3	52.5	41.7	25.0	15.9

### 3. Refrigerant Cycle Diagram

#### 3.2 Refrigeration circuit drawing of 18DV-1

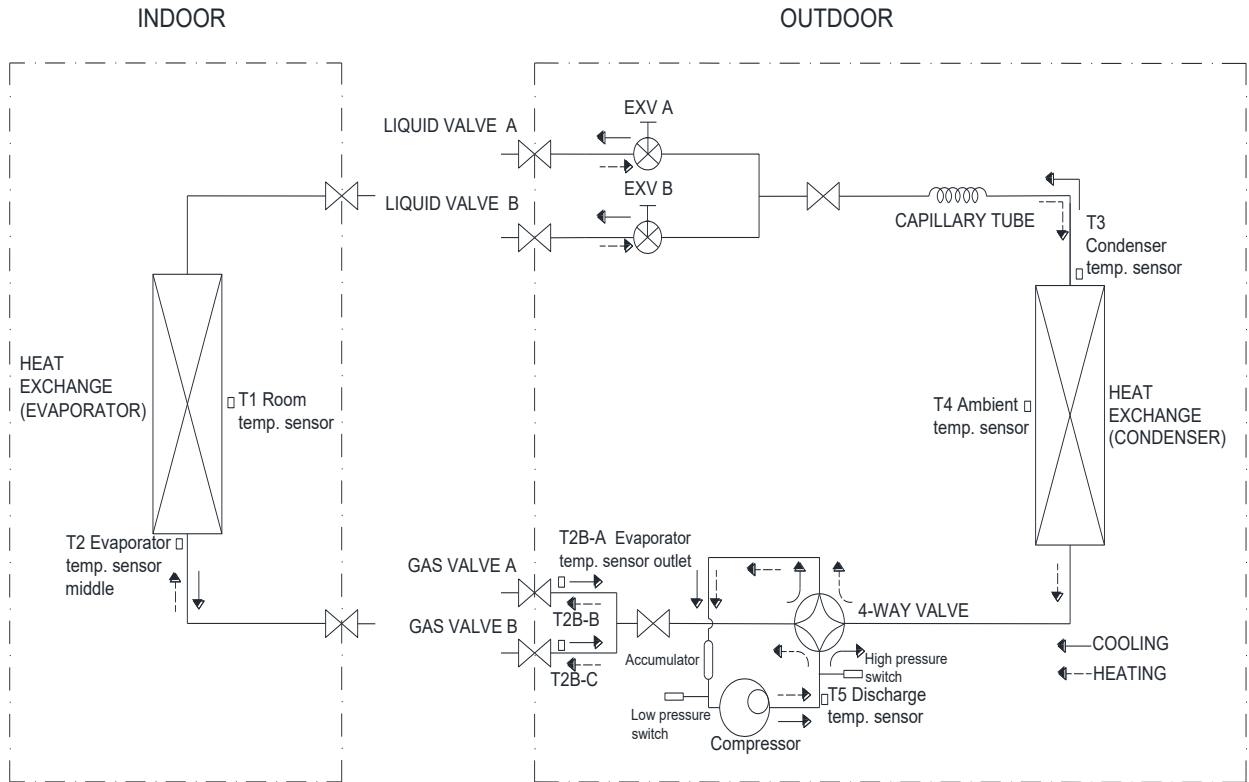

#### 3.3 Refrigeration circuit drawing of 28TV-1

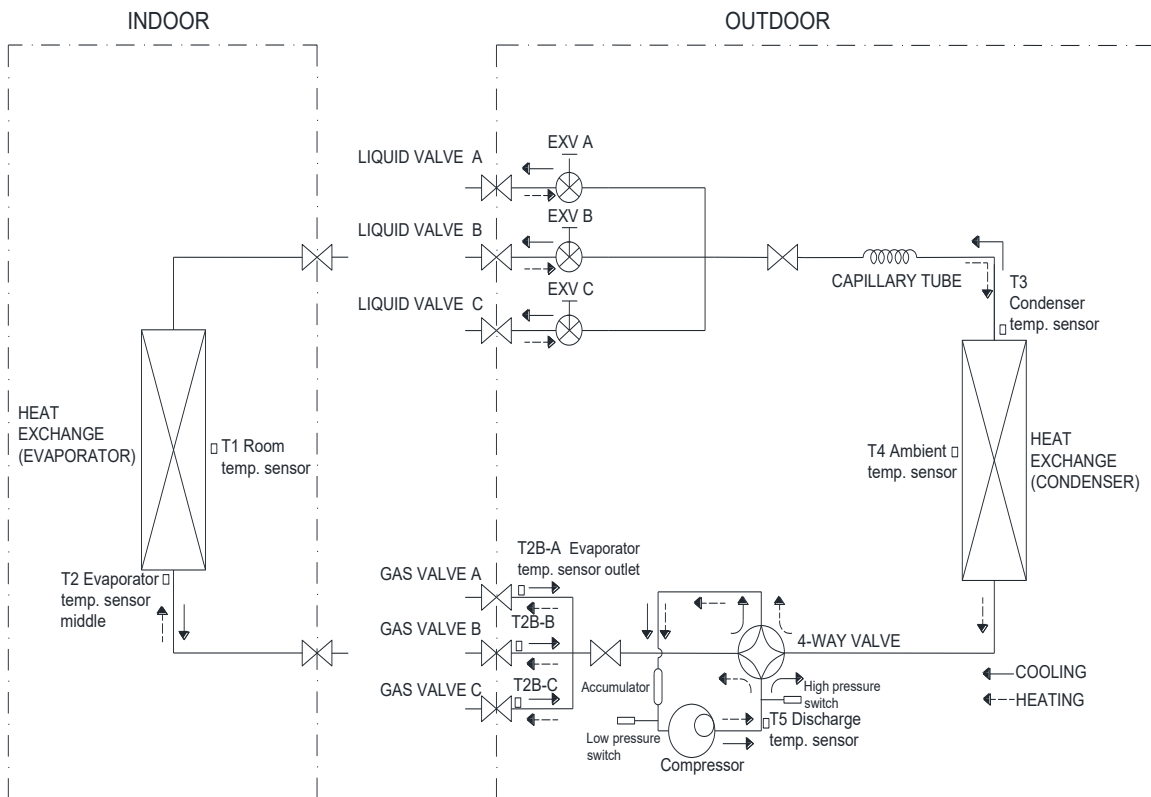

### 3.4 Refrigeration circuit drawing of 36QV-1

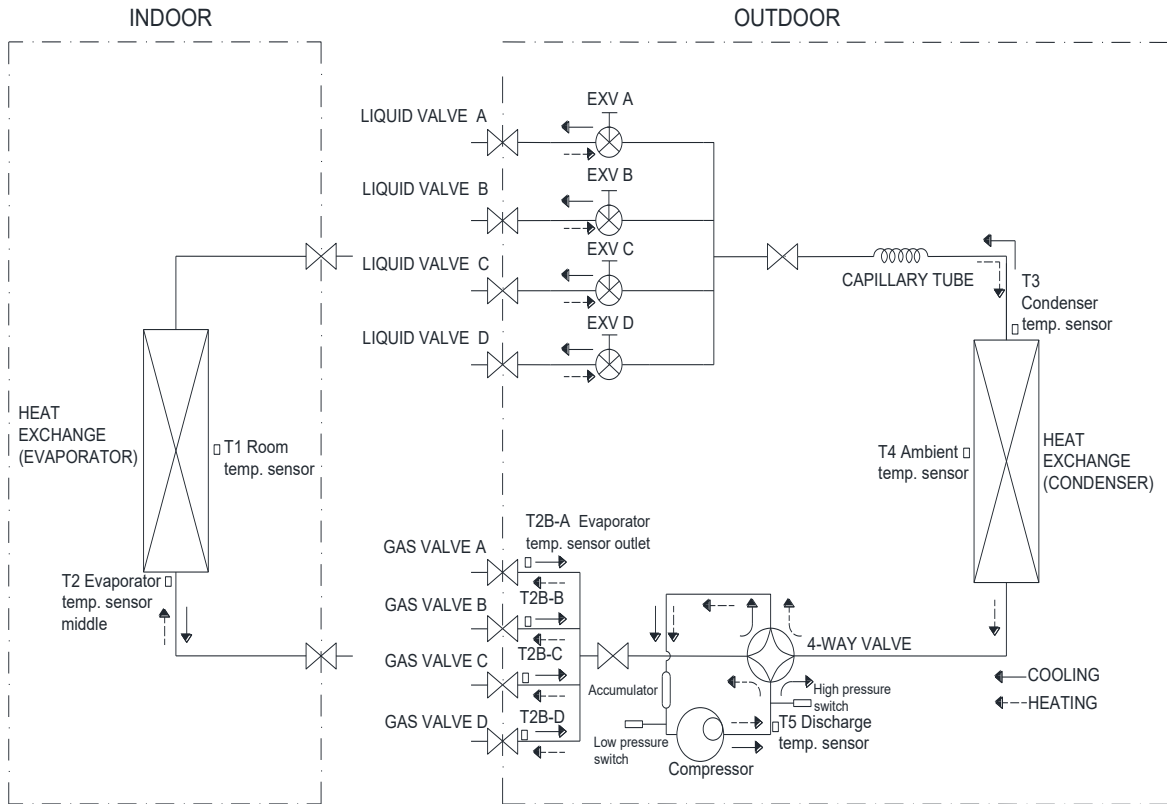

### 3.6 Refrigeration circuit drawing of 48PV-1

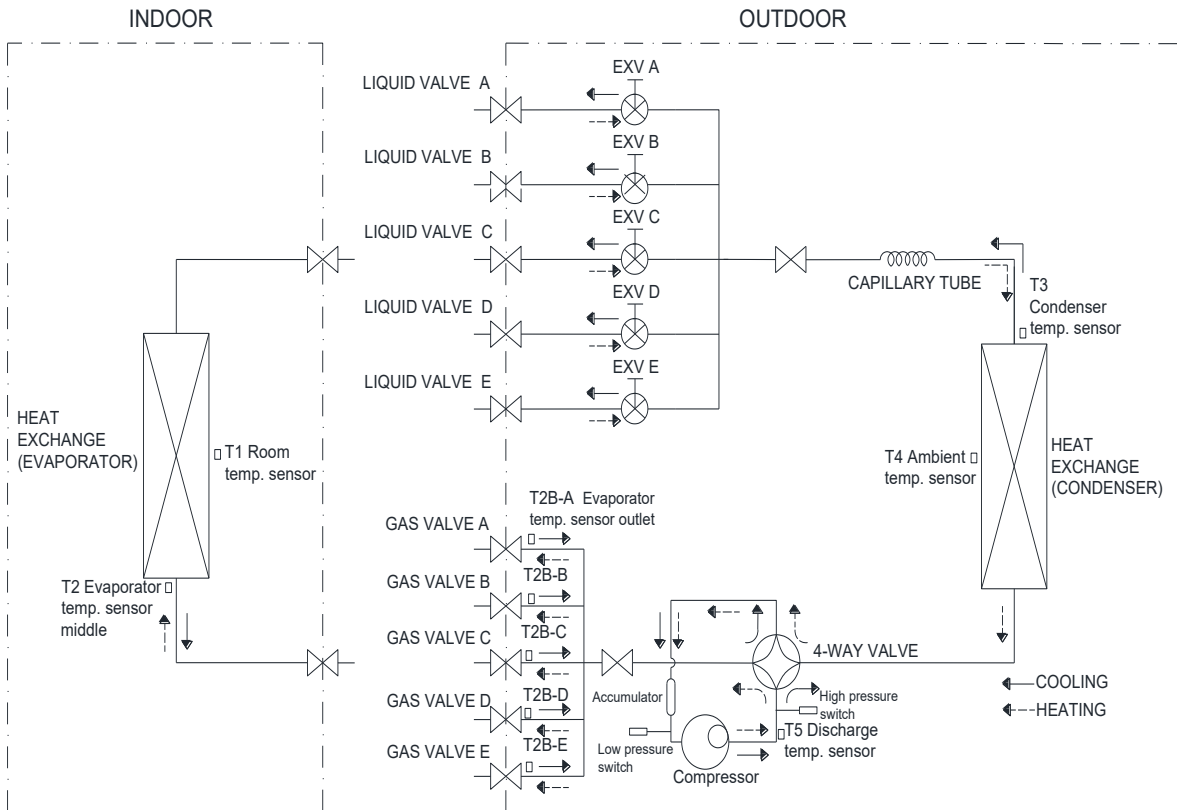

## 4. Installation Details

### 4.1 Wrench torque sheet for installation

Outside diameter		Torque	Additional tightening torque
mm	inch	N.cm	N.cm
Φ6.35	1/4	1500(153kgf.cm)	1600(163kgf.cm)
Φ9.52	3/8	2500(255kgf.cm)	2600(265kgf.cm)
Φ12.7	1/2	3500(357kgf.cm)	3600(367kgf.cm)

### 4.2 Connecting the cables

The power cord connection should be selected according to the following specifications sheet.

Unit	AWG
1 drive 2 type (18K outdoor unit)	14
1 drive 3 type (27K outdoor unit).	14
1 drive 4 type (36K outdoor unit)	12
1 drive 5 type (48K outdoor unit)	10

For indoor unit and outdoor unit connection line, 16AWG is ok for all.

### 4.3 Pipe length and the elevation

#### Maximum piping length and height difference

	1 drive 2	1 drive 3	1 drive 4	1 drive 5
Max. length for all rooms (m)	40 (131ft)	60 (197ft)	80 (262ft)	80 (262ft)
Max. length for one IU (m)	25 (82ft)	30 (98ft)	35 (115ft)	35 (115ft)
Max. height difference between IU and OU (m)	15 (49.2ft)	15 (49.2ft)	15 (49.2ft)	15 (49.2ft)
Max. height difference between IUs (m)	10 (33ft)	10 (33ft)	10 (33ft)	10 (33ft)

#### Additional refrigerant charge

Connective Pipe Length(m)	Additional refrigerant	
	Liquid Side	Gas Side
Pre-charge pipe length (ft/m) (pre-charge pipe length xN )	Ø 6.35 (1/4")	Ø 9.52 (3/8")
More than (pre-charge pipe lengthxN) ft/m	(Total pipe length - pre-charge pipe lengthxN) x15g/m	(Total pipe length - pre-charge pipe lengthxN) x30g/m
	(Total pipe length - pre-charge pipe lengthxN) x0.16oz/ft	(Total pipe length - pre-charge pipe lengthxN) x0.32oz/ft

Note:The standard pipe length is 7.5m

#### Caution:

- Refrigerant pipe diameter is different according to indoor unit to be connected. When using the extension pipe, refer to the tables below.
- When refrigerant pipe diameter is different from that of the outdoor unit connector (18K indoor unit) an additional adapter is required.

Indoor unit		Extension pipe diameter (mm/inch)	
Model	Pipe diameter (mm/inch)		
9K	Liquid	6.35(1/4)	Liquid 6.35(1/4)
	Gas	9.52(3/8)	Gas 9.52(3/8)
12K 18K	Liquid	6.35(1/4)	Liquid 6.35(1/4)
	Gas	12.7(1/2)	Gas 12.7(1/2)
24K	Liquid	9.52 (3/8)	Liquid 9.52 (3/8)
	Gas	15.9(5/8)	Gas 15.9(5/8)
Outdoor unit union diameter (mm/inch)			
1 drive 2	Liquid	6.35(1/4) *2	
	Gas	9.52(3/8) *2	
1 drive 3	Liquid	6.35(1/4) *3	
	Gas	9.52(3/8) *3	
1 drive 4	Liquid	6.35(1/4) *4	
	Gas	9.52(3/8) *3	
		12.7(1/2) *1	
1 drive 5	Liquid	6.35(1/4) *5	
	Gas	9.52(3/8) *3	
		12.7(1/2) *2	

### 4.4 First-Time Installation

Air and moisture in the refrigerant system cause the following problems:

- Increases in system pressure
- Increases in operating current
- Decreases in cooling and heating efficiency
- Blocks in capillary piping caused by moisture in the refrigerant circuit freezing
- Corrosion of parts in the refrigerant system caused by water

The indoor units and the pipes between indoor and outdoor units must be tested for leakages and evacuated to remove gas and moisture from the system.

Gas leak check with soap water:

Apply soap water or a liquid neutral detergent on the connections with a soft brush to check for leakage in the pipe connecting points. If bubbles emerge, the pipes are leaking.

## 1. Air Purging Using the Vacuum Pump

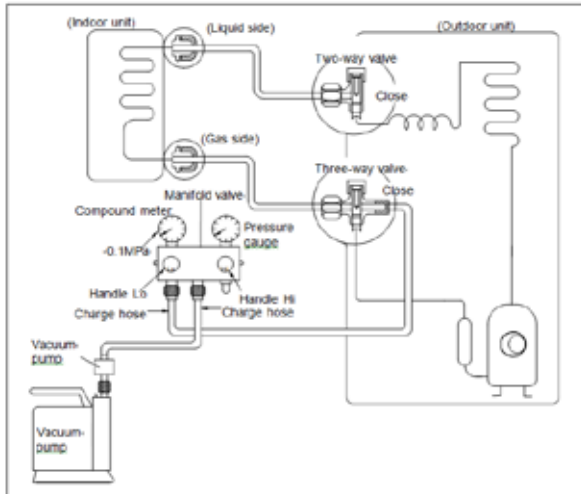

1. Completely tighten the flare nuts on the indoor and outdoor units. Confirm that both the 2-way and 3-way valves are set to the closed position.
  2. Connect the charge hose with the push pin of the Handle Lo to the 3-way valve gas service port.
  3. Connect the charge hose of the Handle Hi to the vacuum pump.
  4. Fully open the Handle Lo of the manifold valve.
  5. Turn on the vacuum pump to begin evacuation.
  6. Conduct a 30-minute evacuation. Check whether the compound meter indicates -0.1Mpa(14.5Psi). If the meter does not indicate -0.1Mpa(14.5Psi) after 30 minutes has elapsed, continue evacuation for 20 more minutes. If the pressure does not reach -0.1Mpa(14.5Psi) after 50 minutes has elapsed, check if there are any leaks.
- Fully close the Handle Lo valve of the manifold valve and turn off the vacuum pump. After 5 minutes, confirm that the gauge needle is not moving.
7. Turn the flare nut on the 3-way valve 45° counterclockwise for 6-7 seconds. Once gas begins to come out, tighten the flare nut. Make sure the pressure display on the pressure indicator is higher than atmospheric pressure. Then remove the charge hose from the 3-way valve.
  8. Fully open the 2-way and 3-way valves and securely tighten the cap on the 3-way valve.

## 2. Adding refrigerant if the pipe length exceeds chargeless pipe length

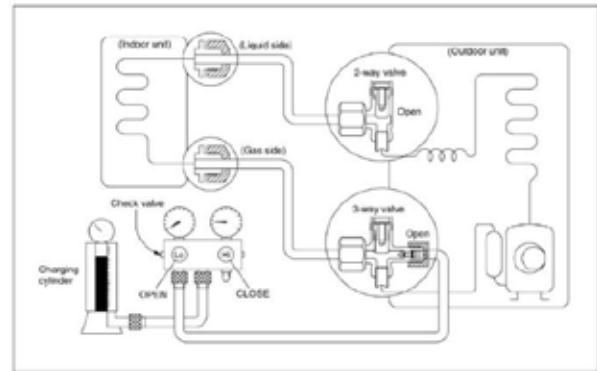

### Procedure:

- 1) Connect the charge hose to the charging cylinder and open the 2-way and 3-way valves. With the charge hose you disconnected from the vacuum pump, connect it to the valve at the bottom of the cylinder.

If the refrigerant is R410A, place the cylinder bottom-up to ensure liquid charging is possible.

- 2). Purge the air from the charge hose. Open the valve at the bottom of the cylinder and press the check valve on the charge set (be careful of the liquid refrigerant).
- 3) Place the charging cylinder onto the electronic scale and record the weight.
- 4) Turn on the air conditioner in cooling mode.
- 5) Open the valves (Low side) on the charge set. Charge the system with liquid refrigerant.
- 6). When the electronic scale displays the proper weight (refer to the table), disconnect the charge hose from the 3-way valve's service port immediately and turn off the air conditioner before disconnecting the hose.
- 7). Mount the valve stem caps and the service port. Use a torque wrench to tighten the service port cap to a torque of 18N.m(13.27 ft-lbs).

Be sure to check for gas leaks.

## 4.5 Adding Refrigerant after Long-Term System Operation

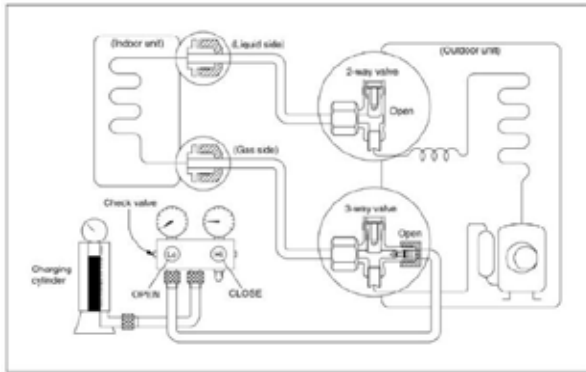

### Procedure

- 1) Connect the charge hose to the 3-way service port and open the 2-way and 3-way valve. Connect the charge hose to the valve at the bottom of the cylinder. If the refrigerant is R410A, place the cylinder bottom-up to ensure liquid charge.
- 2). Purge the air from the charge hose. Open the valve at the bottom of the cylinder and press the check valve on the charge set to purge the air (be careful of the liquid refrigerant).
- 3) Place the charging cylinder onto the electronic scale and record the weight.
- 4) Turn on the air conditioner in cooling mode.
- 5) Open the valves (Low side) on the charge set and charge the system with liquid refrigerant.
- 6). When the electronic scale displays the proper weight (refer to the gauge and the pressure of the low side), disconnect the charge hose from the 3-way valve's service port immediately and turn off the air conditioner before disconnecting the hose.
- 7). Mount the valve stem caps and the service port. Use torque wrench to tighten the service port cap to a torque of 18N.m(13.27 ft·lbs).

Be sure to check for gas leaks.

## 4.6 Procedure when servicing the indoor unit refrigeration circuit.

### 1. Collecting the refrigerant into the outdoor unit

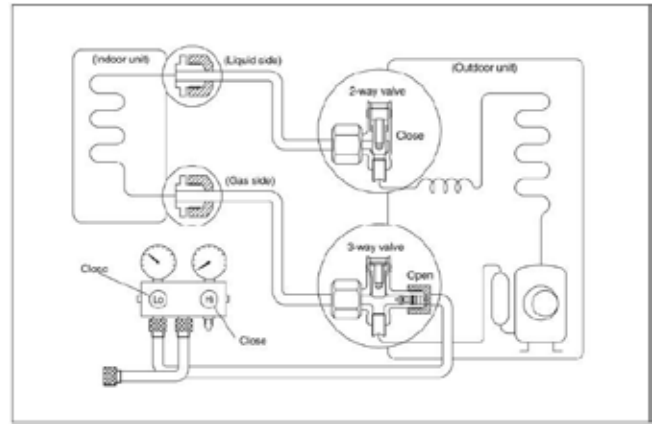

### Procedure

- 1). Confirm that both the 2-way and 3-way valves are set to the opened position. Remove the valve stem caps and confirm that the valve stems are in the opened position. Be sure to use a hexagonal wrench to operate the valve stems.
- 2). Connect the charge hose with the push pin of handle Lo to the 3-way valves gas service port.
- 3). Air purging of the charge hose. Open the handle Lo valve of the manifold valve slightly to purge air from the charge hose for 5 seconds and then close it quickly.
- 4). Set the 2-way valve to the close position.
- 5). Operate the air conditioner at the cooling cycle and stop it when the gauge indicates 0.1MPa.
- 6). Set the 3-way valve to the closed position immediately. Do this quickly so that the gauge ends up indicating 0.3 to 0.5Mpa. Disconnect the charge set, and tighten the 2-way and 3-way valve's stem nuts. Use a torque wrench to tighten the 3-way valves service port cap to a torque of 18N.m. Be sure to check for gas leakage.

### 2. Air purging with vacuum pump

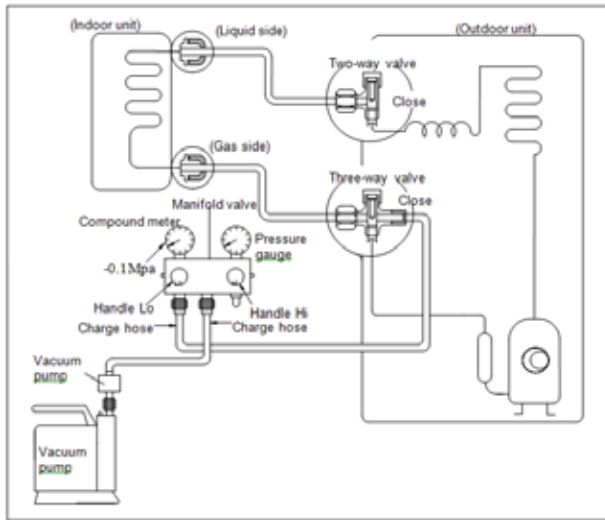

- 1) Completely tighten the flare nuts of the indoor and outdoor units, confirm that both the 2-way and 3-way valves are set to the closed position.
- 2) Connect the charge hose with the push pin of handle lo to the 3-way valves gas service port.
- 3) Connect the charge hose of handle hi connection to the vacuum pump.
- 4) Fully open the handle Lo of the manifold valve.
- 5) Operate the vacuum pump to evacuate.
- 6) Make evacuation for 30 minutes and check whether the compound meter indicates -0.1Mpa. If the meter does not indicate -0.1Mpa after pumping 30 minutes, it should be pumped 20 minutes more. If the pressure can't achieve -0.1Mpa after pumping 50 minutes, please check if there are some leakage points.

Fully close the handle Lo valve of the manifold valve and stop the operation of the vacuum pump. Confirm that the gauge needle does not move (approximately 5 minutes after turning off the vacuum pump).

- 7) Turn the flare nut of the 3-way valves about 45° counterclockwise for 6 or 7seconds after the gas coming out, then tighten the flare nut again. Make sure the pressure display in the pressure indicator is a little higher than the atmosphere pressure. Then remove the charge hose from the 3 way valve.

- 8) Fully open the 2 way valve and 3 way valve and securely tighten the cap of the 3 way

valve.

## 4.7 Evacuation after servicing the outdoor unit refrigeration circuit

### 1. Evacuation of the complete refrigeration circuit, Indoor and outdoor unit.

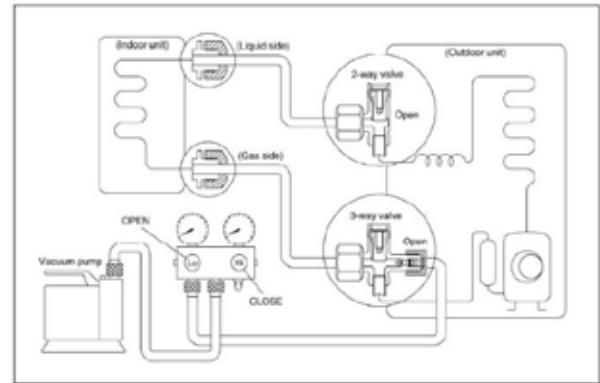

#### Procedure:

- 1). Confirm that both the 2-way and 3-way valves are set to the opened position.
- 2). Connect the vacuum pump to 3-way valve's service port.
- 3). Evacuation for approximately one hour. Confirm that the compound meter indicates -0.1Mpa (500 Microns / 29.9 in,hg).
- 4). Close the valve (Low side) on the charge set, turn off the vacuum pump, and confirm that the gauge needle does not move (approximately 5 minutes after turning off the vacuum pump).
- 5). Disconnect the charge hose from the vacuum pump.

### 2. Refrigerant charging

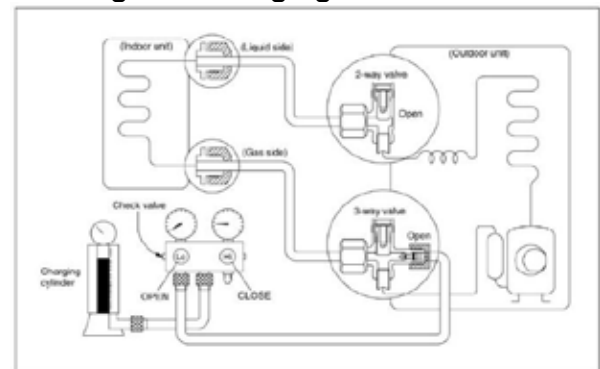

#### Procedure:

- 1). Connect the charge hose to the charging cylinder, open the 2-way valve and the 3-way valve. Connect the charge hose which you disconnected

from the vacuum pump to the valve at the bottom of the cylinder. If the refrigerant is R410A, make the cylinder bottom up to ensure liquid charge.

2). Purge the air from the charge hose

Open the valve at the bottom of the cylinder and press the check valve on the charge set to purge the air (be careful of the liquid refrigerant).

3) Put the charging cylinder onto the electronic scale and record the weight.

4). Open the valves (Low side) on the charge set and charge the system with liquid refrigerant

If the system cannot be charge with the specified amount of refrigerant, or can be charged with a little at a time (approximately 150g each time) , operating the air conditioner in the cooling cycle; however, one time is not sufficient, wait approximately 1 minute and then repeat the procedure.

5).When the electronic scale displays the proper weight, disconnect the charge hose from the 3-way valve's service port immediately

If the system has been charged with liquid refrigerant while operating the air conditioner, turn off the air conditioner before disconnecting the hose.

6). Mounted the valve stem caps and the service port. Use torque wrench to tighten the service port cap to a torque of 18N·m (13.27 ft·lbs).

Always leak check after servicing the refrigerant system.

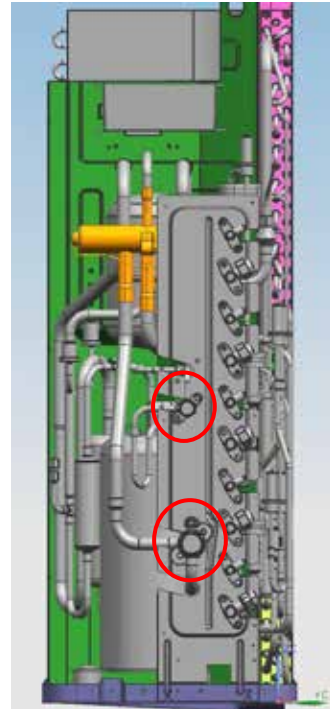

## 5. Electronic Function

### 5.1 Abbreviation

T1: Indoor ambient temperature

T2: Middle indoor heat exchanger coil temperature

T2B: Indoor heat exchanger exhaust coil temperature (located on the outdoor unit)

T3: Outdoor heat exchanger pipe temperature

T4: Outdoor ambient temperature

T5: Compressor discharge temperature

### 5.2 Electric Control Working Environment.

5.2.1 Input voltage: 230V.

5.2.2 Input power frequency: 60Hz.

5.2.3 Indoor fan standard working amp.: <1A

5.2.4 Outdoor fan standard working amp.: <1.5A.

5.2.5 Four-way valve standard amp.: <1A.

### 5.3 Main Protection

#### 5.3.1 Compressor Restart Delay

---- The compressor takes 1 minute to start up the first time. Further restarts take 3 minutes.

#### 5.3.2 Temperature Protection of Compressor Discharge.

When the discharge temperature of the compressor rises, the running frequency is limited according to the following rules:

----If  $105^{\circ}\text{C}$  ( $221^{\circ}\text{F}$ )  $\leq T5 < 110^{\circ}\text{C}$  ( $230^{\circ}\text{F}$ ), maintain the current frequency.

----If the temperature increase and  $T5 \geq 110^{\circ}\text{C}$  ( $230^{\circ}\text{F}$ ), decrease the frequency to a lower level every 2 minutes till to F1.

---If  $T5 \geq 115^{\circ}\text{C}$  ( $239^{\circ}\text{F}$ ) for 10 seconds, the compressor stops and then restart until  $T5 < 90^{\circ}\text{C}$  ( $194^{\circ}\text{F}$ ).

#### 5.3.3 Fan Speed Malfunction

---- If outdoor fan speed is lower than **100RPM** or higher than 2400RPM for 60 seconds or more, the unit stops and LED displays failure code.

#### 5.3.4 Inverter Module Protection.

---- The inverter protection module ensures that faults related to current, voltage, or temperature does not damage the inverter.

If these protections are triggered, the A/C unit stops and the LED displays the failure code.

The unit restarts 3 minutes after the protection mechanism has turned off.

#### 5.3.5 Low Voltage Protection

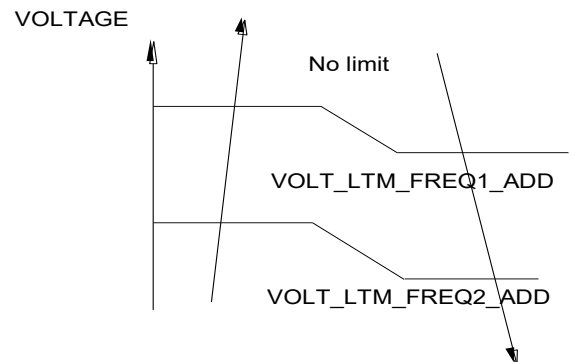

Note: If low voltage protection triggers and voltage is not restored to normal within 3 minutes, the protection remains active even after a machine restart.

#### 5.3.6 Compressor Current Limit Protection

The temperature interval for the current limit is the same as the range of the T4 frequency limit.

#### Cooling mode:

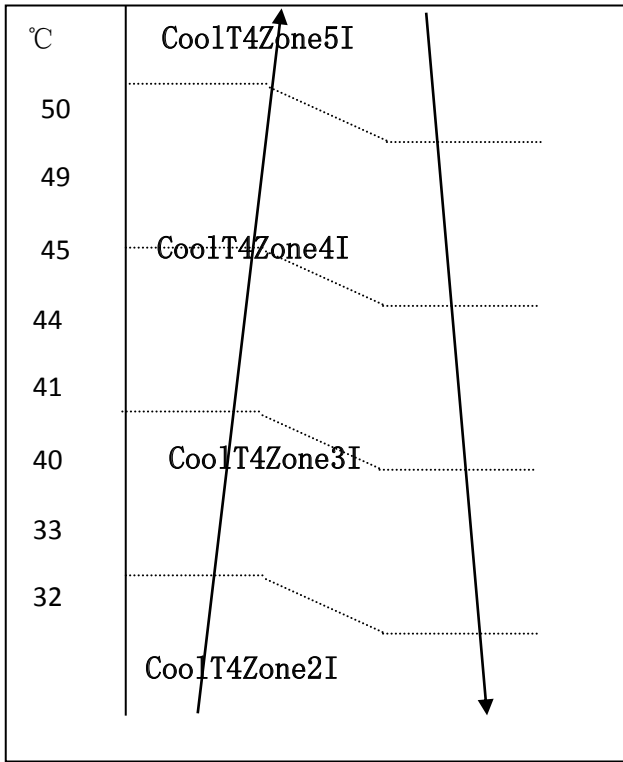

CoolReturnI	The difference between current limit and shutdown current
CoolT4Zone5I	Cooling $T4 \geq 50^\circ\text{C}$ current limit value
CoolT4Zone4I	Cooling $49 > T4 \geq 45^\circ\text{C}$ current limit value
CoolT4Zone3I	Cooling $44 > T4 \geq 41^\circ\text{C}$ current limit value
CoolT4Zone2I	Cooling $40 > T4 \geq 33^\circ\text{C}$ current limit value
CoolT4Zone1I	Cooling $32 > T4^\circ\text{C}$ current limit value
CoolStopI	Cooling stop protection current value

**Heating mode:**

For other models,

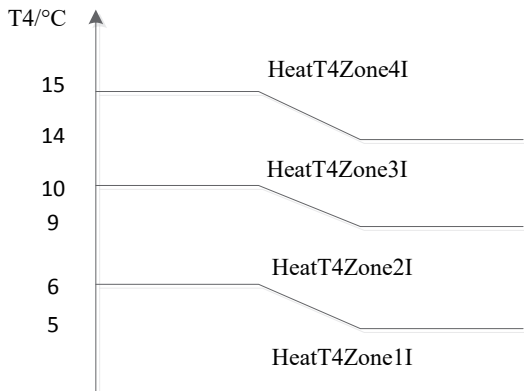

<b>HeatReturnI</b>	The difference between current limit
--------------------	--------------------------------------

	and shutdown current
<b>HeatT4Zone4I</b>	Heating $T4 \geq 15^\circ\text{C}$ current limit value
<b>HeatT4Zone3I</b>	Heating $14^\circ\text{C} > T4 \geq 10^\circ\text{C}$ current limit value
<b>HeatT4Zone2I</b>	Heating $9^\circ\text{C} > T4 \geq 6^\circ\text{C}$ current limit value
<b>HeatT4Zone1I</b>	Heating $5^\circ\text{C} > T4$ current limit value
<b>HeatStopI</b>	Heating stop protection current value

For A-VMH48PV-1, A-VMH36QV-1

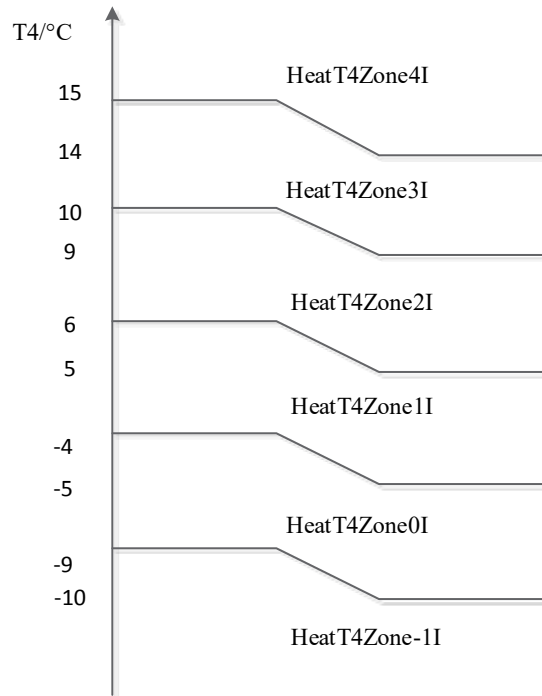

<b>HeatReturnI</b>	The difference between current limit and shutdown current
<b>HeatT4Zone4I</b>	Heating $T4 \geq 15^\circ\text{C}$ current limit value
<b>HeatT4Zone3I</b>	Heating $14^\circ\text{C} > T4 \geq 10^\circ\text{C}$ current limit value
<b>HeatT4Zone2I</b>	Heating $9^\circ\text{C} > T4 \geq 6^\circ\text{C}$ current limit value
<b>HeatT4Zone1I</b>	Heating $5^\circ\text{C} > T4 \geq -4^\circ\text{C}$ current limit value
<b>HeatT4Zone0I</b>	Heating $-5^\circ\text{C} > T4 \geq -9^\circ\text{C}$ current limit value

<b>HeatT4Zone-1I</b>	Heating $-10^{\circ}\text{C} > \text{T4}$ current limit value
<b>HeatStopI</b>	Heating stop protection current value

### 5.3.7 Indoor / Outdoor Units Communication Protection

If the indoor units do not receive the feedback signal from the outdoor units for 2 consecutive minutes, the unit stops. The unit displays the failure code.

### 5.3.8 High Condenser Coil Temp. Protection

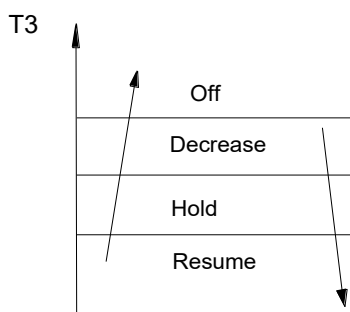

### 5.3.9 Outdoor Unit Anti-Freezing Protection

When  $\text{T2} < 4^{\circ}\text{C}$  for 250seconds or  $\text{T2} < 0^{\circ}\text{C}$ , the indoor unit capacity demand is zero and resumes normal operation when  $\text{T2} > 8^{\circ}\text{C}$  and the protection time is no less than 3 minutes.

### 5.3.10 Oil Return

#### Rules for Operation

1. If the compressor frequency continues to be lower than the frequency set for setting time, the unit raises the frequency to the frequency set for setting time and then resumes with the former frequency.

2. The EXV continues at 300p while indoor units maintain their operation.

If the outdoor ambient temperature is higher than the set frequency during oil return, the unit stops the oil return process.

### 5.3.11 Low Outdoor Ambient Temperature Protection

When the compressor is off and T4 is lower than  $-35^{\circ}\text{C}$  for 10 seconds, the unit stops and displays "LP" or "PC0L"

When the compressor is on and T4 remains lower than  $-40^{\circ}\text{C}$  for 10 seconds, the unit stops and displays "LP" or "PC0L"

When T4 is no lower than  $-32^{\circ}\text{C}$  for 10 seconds, the unit exits protection.

## 5.4 Control and Functions

### 5.4.1 Capacity Request Calculation

For Old Console series, Old Duct/Cassette/Floor Ceiling, Old Vertu/Luna Series:

Total capacity Request =  $\Sigma(\text{Norm code} \times \text{HP}) / 10 \times \text{modify rate} + \text{correction}$

For All new models(New Wall mounted(Hi-Wall) series, New Duct/Cassette/Console/Floor Ceiling):

Total capacity Request =  $\Sigma(\text{Norm code} \times \text{HP}) / 40 \times \text{modify rate} + \text{correction}$

#### Cooling Mode:

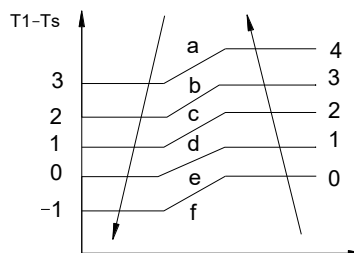

Capacity area	a	b	c	d	e	f
Norm code (N)	3	2	1.5	1	0.5	0

Model	9K	12K	18K	24K
HP	1.0	1.2	1.5	2.5

**Note: The final result is an integer.**

Use the following table and final capacity request to confirm the operating frequency.

Frequency (Hz)	0	COO L_F1	COO L_F2	...	COOL _F24	COO L_F2 5
Amendatory capacity demand.	0	1	2	...	24	25

HP	1.0	1.2	1.5	2.5
----	-----	-----	-----	-----

**Note: The final result is an integer.**

**Then modify it according to a T2 average (correction):**

Note: Average value of T2: Sum T2 value of all indoor units/ (indoor units number

The maximum running frequency is adjusted according to the outdoor ambient temperature

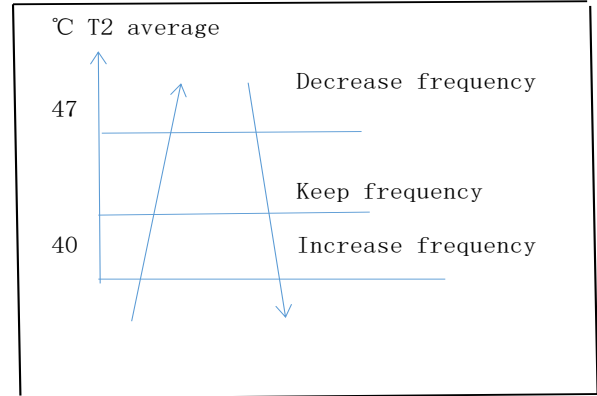
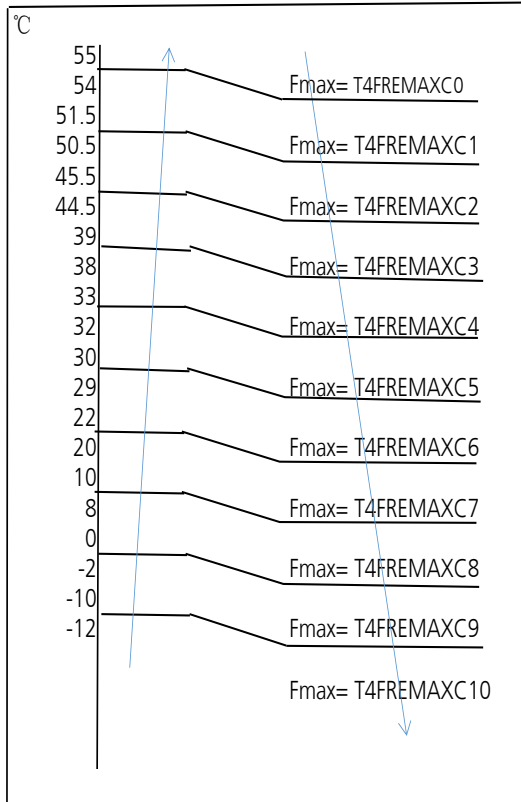

**Use the following table and final capacity request to confirm the operating frequency.**

Frequency (Hz)	0	HEAT _F1	HEAT _F2	...	HEAT _F24	HEAT _F25
Amendatory capacity demand.	0	1	2	...	24	25

The maximum running frequency is adjusted according to the outdoor ambient temperature

### Heating Mode

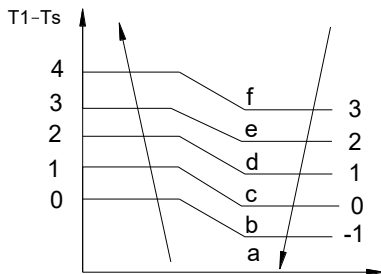

Capacity area	a	b	c	d	e	f
Norm code (N)	3	2	1.5	1	0.5	0

Model	9K	12K	18K	24K
-------	----	-----	-----	-----

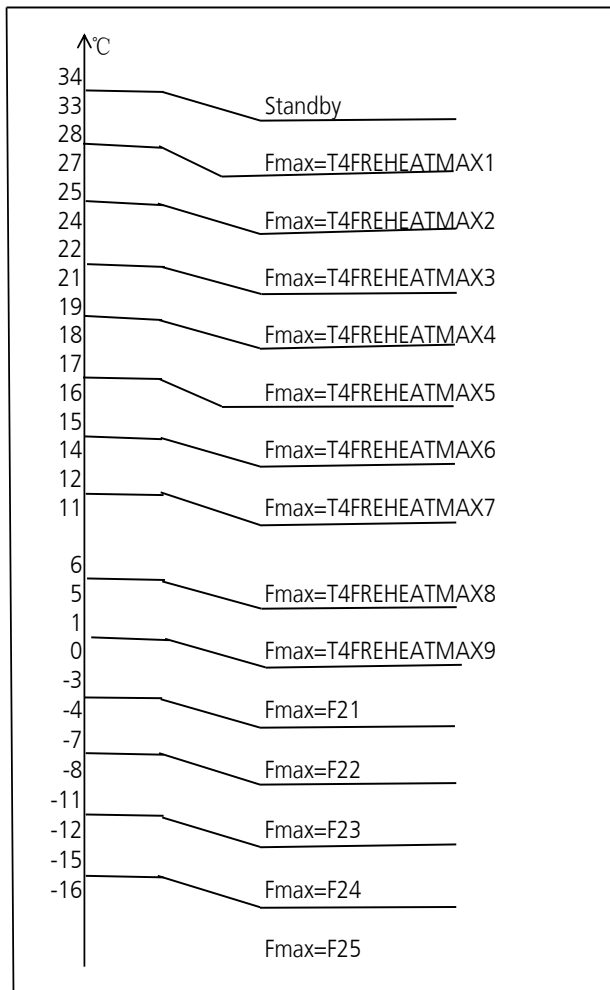

## 5.4.2 Defrosting Control

### Conditions for Defrosting:

After the compressor starts and enters normal operation, mark the minimum value of T3 from the 10th to 15th minute as T30.

If any one of the following conditions is satisfied, the unit enters defrosting mode:

- 1) If the compressor's cumulative running time reaches 29 minutes and  $T3 < TCD11$  and  $T3 + T30SUBT3ONE \leq T30$ .
- 2) If the compressor cumulative running time reaches 35 minutes and  $T3 < TCD12$  and  $T3 + T30SUBT3TWO \leq T30$ .
- 3) If the compressor cumulative running time reaches 40 minutes and  $T3 < -24C$  for 3 minutes.

4) If the compressor cumulative running time reaches 120 minutes and  $T3 < -15^{\circ}C$ .

5) If the air conditioner is shut down from heating mode, it will enter defrost if any of the following conditions are met (this condition can be shielded by parameters):

a) The continuous operation time of the press exceeds 30 minutes, and  $T3 < -7$  degrees;

b) The continuous operation time of the press is more than 30 minutes, and  $T30 < -15$  degrees;

6) For the first defrosting when the machine is turned on, after the compressor has been running for 30 minutes, when  $T4 - T3 > (0.5T4 + KDELTT\_ADD)$  and  $T3 < TCDIN5\_ADD$ , it will immediately enter the defrosting action. After performing this defrosting action once, this rule will be invalid until the next restarting operation.

7) If any one of the following conditions is satisfied, the unit enters defrosting mode,

a) If T3 or T4 is lower than  $-3^{\circ}C$  for 30 seconds,  $Ts - T1$  is lower than  $5^{\circ}C$  and compressor running time is more than DEFROST\_COND6\_IN\_TIM.

b) If T3 or T4 is lower than  $-3^{\circ}C$  for 30 seconds and compressor running time is more than DEFROST\_COND6\_IN\_TIM + 30.

### Defrost Stop Conditions

If any one of the following conditions is satisfied, defrosting ends and the unit returns to normal heating mode:

----T3 rises above than  $TCDE1^{\circ}C$ .

----T3 remains at  $TCDE2^{\circ}C$  or above for 80 seconds.

----The machine runs for 10 consecutive minutes in defrosting mode.

### Defrosting Action:



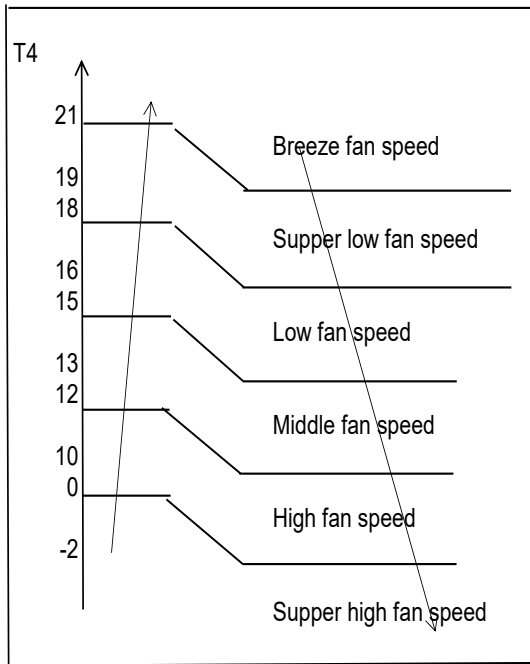

#### 5.4.4 Electronic Expansion Valve (EXV) For A-VMH48PV-1

1. After the outdoor unit is powered on again, the EXV is first closed -520P, and then in standby mode (if the current mode is heating mode, the initial heating degree is run, otherwise the initial cooling degree is run, and the internal machine is not connected. deal with 7k unit). The main valve first opens 510P, then opens 530P, and then is in the standby state (if the current outdoor mode is the heating mode or the standby mode, it maintains 0P, and the cooling mode opens to the initial cooling opening). The EVI valve opens 510P first, then 530P, then the counter is cleared to 0P.
2. After the compressor is stopped,
  - 2.1 If the EVI valve has a valve opening action before the stop, the PMV\_CLOSE\_EE step is closed in the reverse direction after the stop, and then the EXV opening counter is cleared to 0P. If the EVI valve does not operate before the stop, 0P will be maintained.
  - 2.2 Reverse the valve to close the PMV\_CLOSE\_EE step (after closing the valve to the 0P, and then continue to run PMV\_CLOSE\_EE in the valve closing direction, the EXV opening counter is cleared. If the current opening is 300P, go to the valve Run the 320P in the closing direction to close the EXV.), then in the standby state (if the current outdoor mode is the heating mode, the initial heating opening is

run, otherwise the initial cooling opening is run, and the internal machine is not connected. deal with 7k unit).

2.3 Main EXV action: When the compressor is off, the main EXV keeps the opening degree when the compressor is turned off within the first 90 seconds. If it is currently heating mode, -20P, clear and keep 0P, otherwise adjust to 480P.

3. Other EXV(except for EVI valve) cannot be operated at the same time. The action priority order is A-B-C-D-E-main valve. The EVI valve can be operated together with other EXV.

#### For other models, Control

1. EXV remains fully closed while the device is powering up. EXV then remains on standby with 350P open. It opens to the target angle after the compressor starts.
2. EXV closes with -40P when the compressor stops. Then it remains on standby with 350P open. It opens to the target angle after the compressor starts.
3. The action priority for the EXVs is A-B-C-D-E.
4. The compressor and outdoor fan commence operation only after EXV initializes.

#### 5.4.4.1 Cooling Mode

The initial open angle of the EXV depends on the size of the indoor model. The adjustment range is 100-400p.

When the unit has been running for 3 minutes, the outdoor receives indoor units' capacity demand and T2B information and then calculates their average. After comparing each indoor's T2B with the average, the outdoor gives the following modification commands:

---- If the  $T2B > \text{average}$ , the relevant valve needs to open 16p more

---- If the  $T2B = \text{average}$ , the relevant valve's open range remains as is

---- If the  $T2B < \text{average}$ , the relevant valve needs to close 16p more

This modification is carried out every 2 minutes.

#### 5.4.4.2 Heating Mode

The initial open angle of the EXV depends on the size of the indoor model. The adjustment range is 150-350p.

When the unit has been running for 3 minutes, the outdoor unit receives the indoor units' indoor units' capacity demand and T2 information and then calculates their average.

After comparing each indoor unit's T2 with the average, the outdoor gives the following modification commands:

----If the  $T2 > \text{average} + 2$ , the relevant valve needs to close 16p more

---- If  $\text{average} + 2 \geq T2 \geq \text{average} - 2$ , the relevant valve's open range remains as is

----If the  $T2 < \text{average} - 2$ , the relevant valve needs to open 16p more

This modification is carried out every 2 minutes.

#### **5.4.5 Four-Way Valve Control**

In heating mode, a four-way valve is opened.

In defrosting, a four-way valve operates according to the current defrosting action.

In other modes, a four-way valve is closed.

When the unit is switched from heating to other modes, the four-way valve turns off after the compressor has been off for 2 consecutive minutes.

Failure or protection (excluding discharge temperature protection and high/low pressure protection) causes the four-way valve to immediately shut down.

## 6. Wiring Diagrams

### 6.1 Wiring diagram of 1 drive 2 outdoor

#### 18DV-1

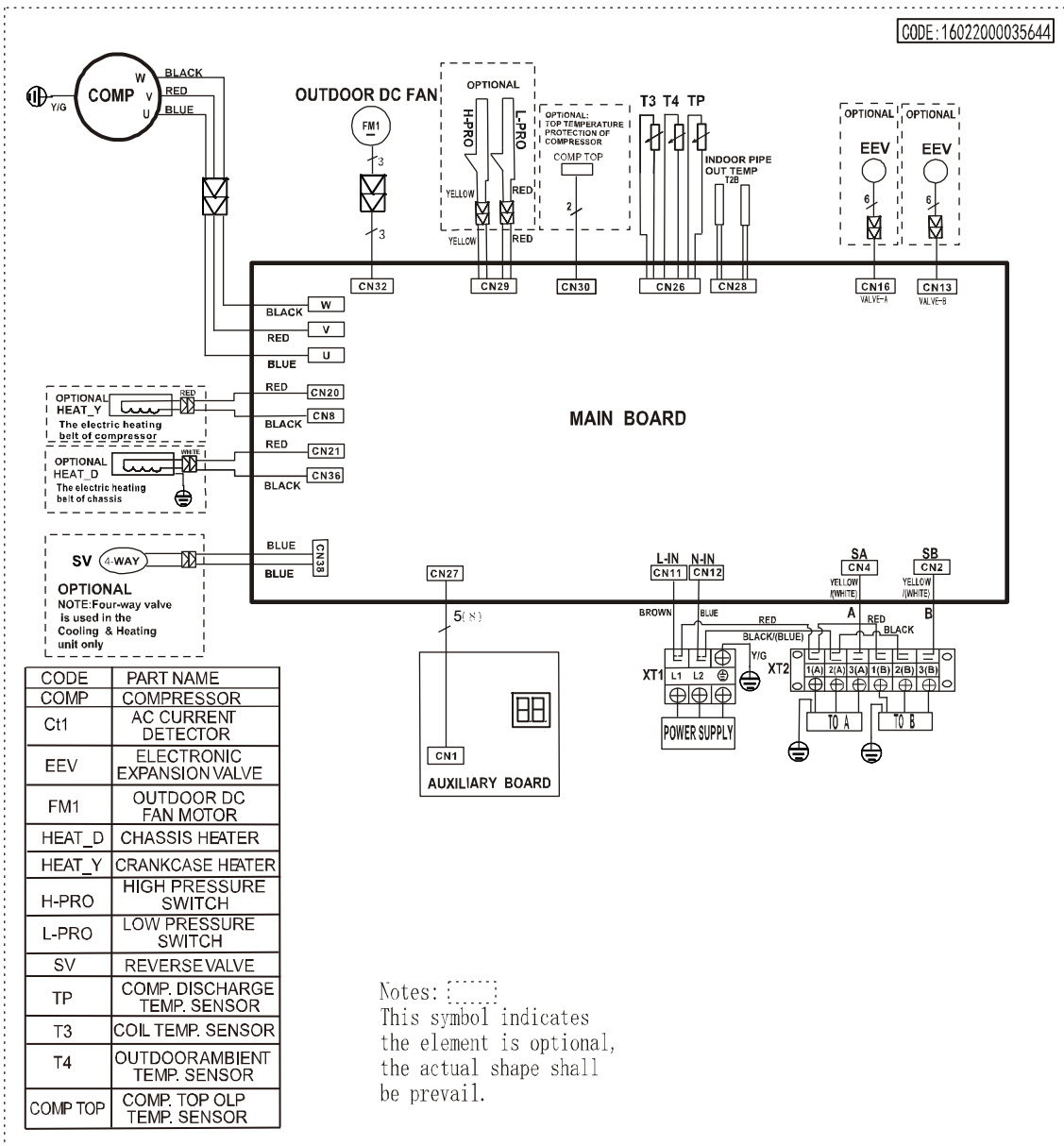

## 6.2 Wiring diagram of 1 drive 3 outdoor 28TV-1

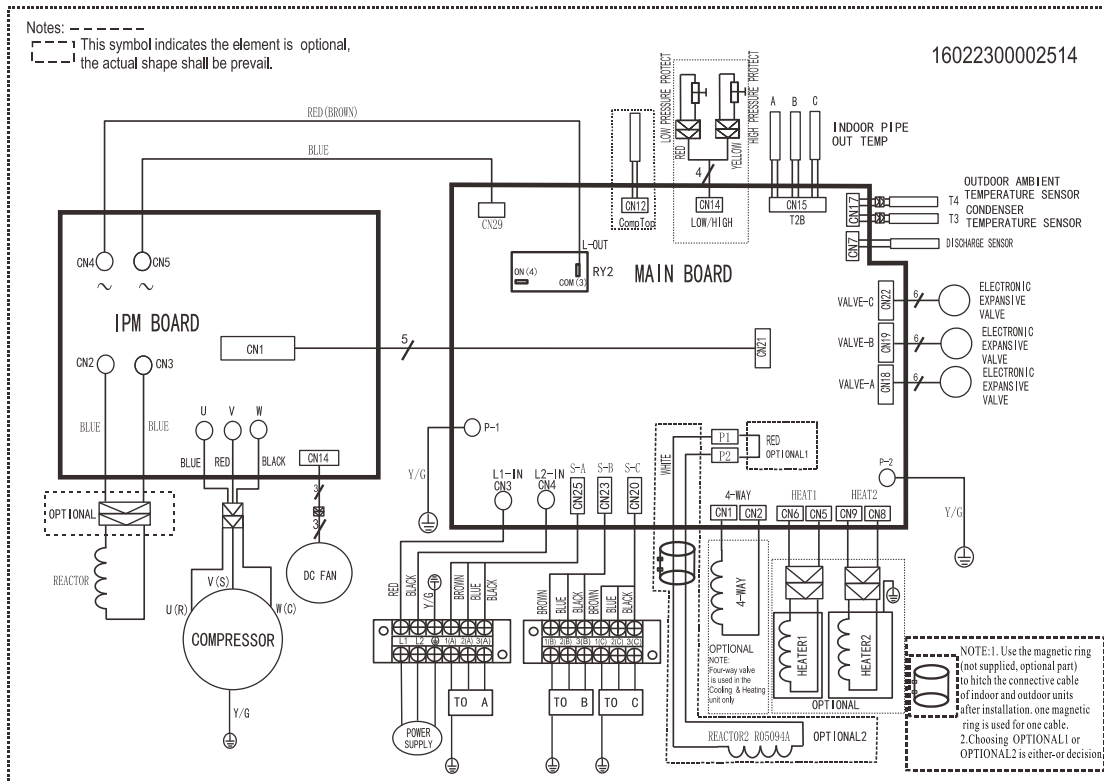

### 6.3 Wiring diagram of 1 drive 4 outdoor 36QV-1

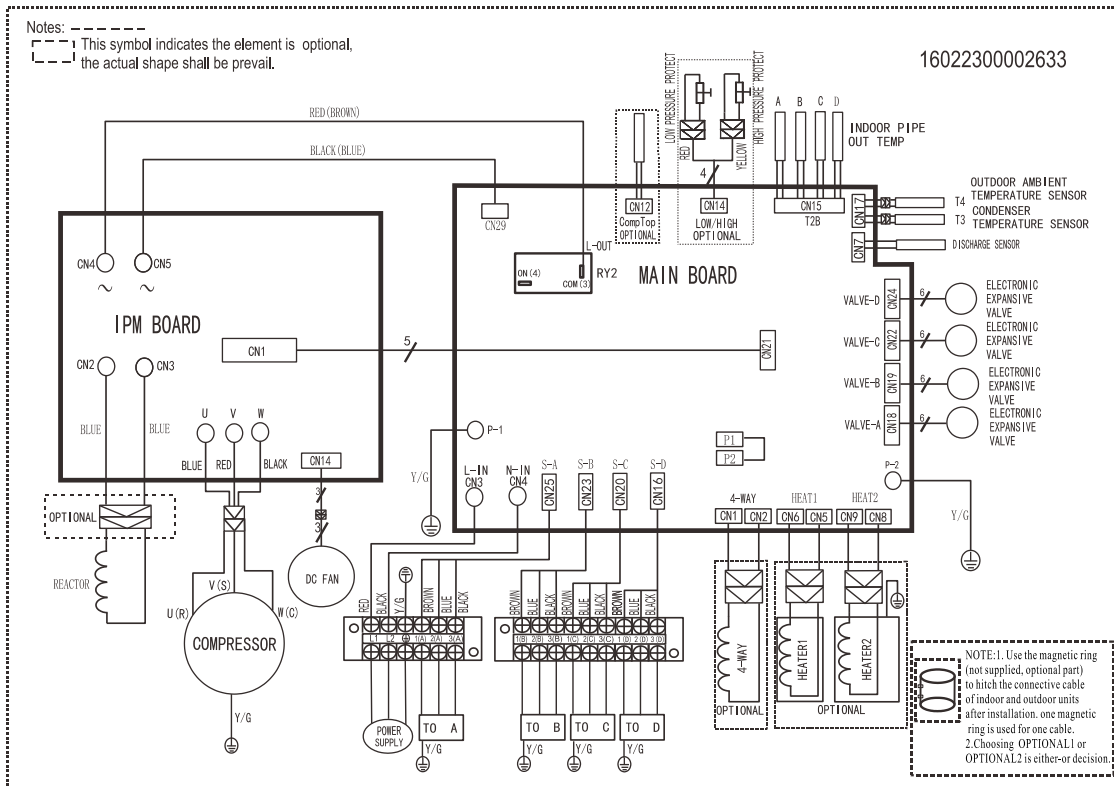

### 6.4 Wiring diagram of 1 drive 5 outdoor 48PV-1

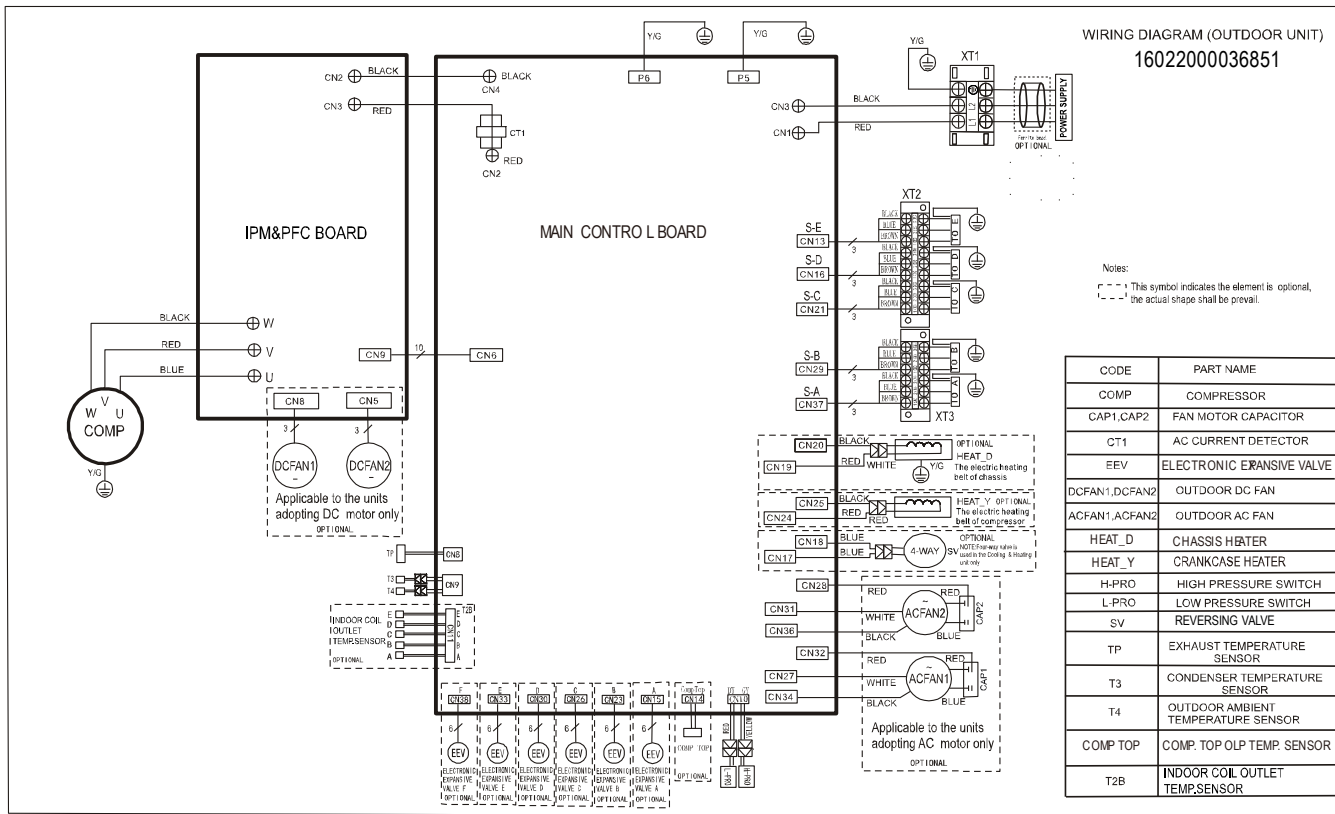

IPM Board of 18DV-1, 28TV-1, 36QV-1, 48PV-1

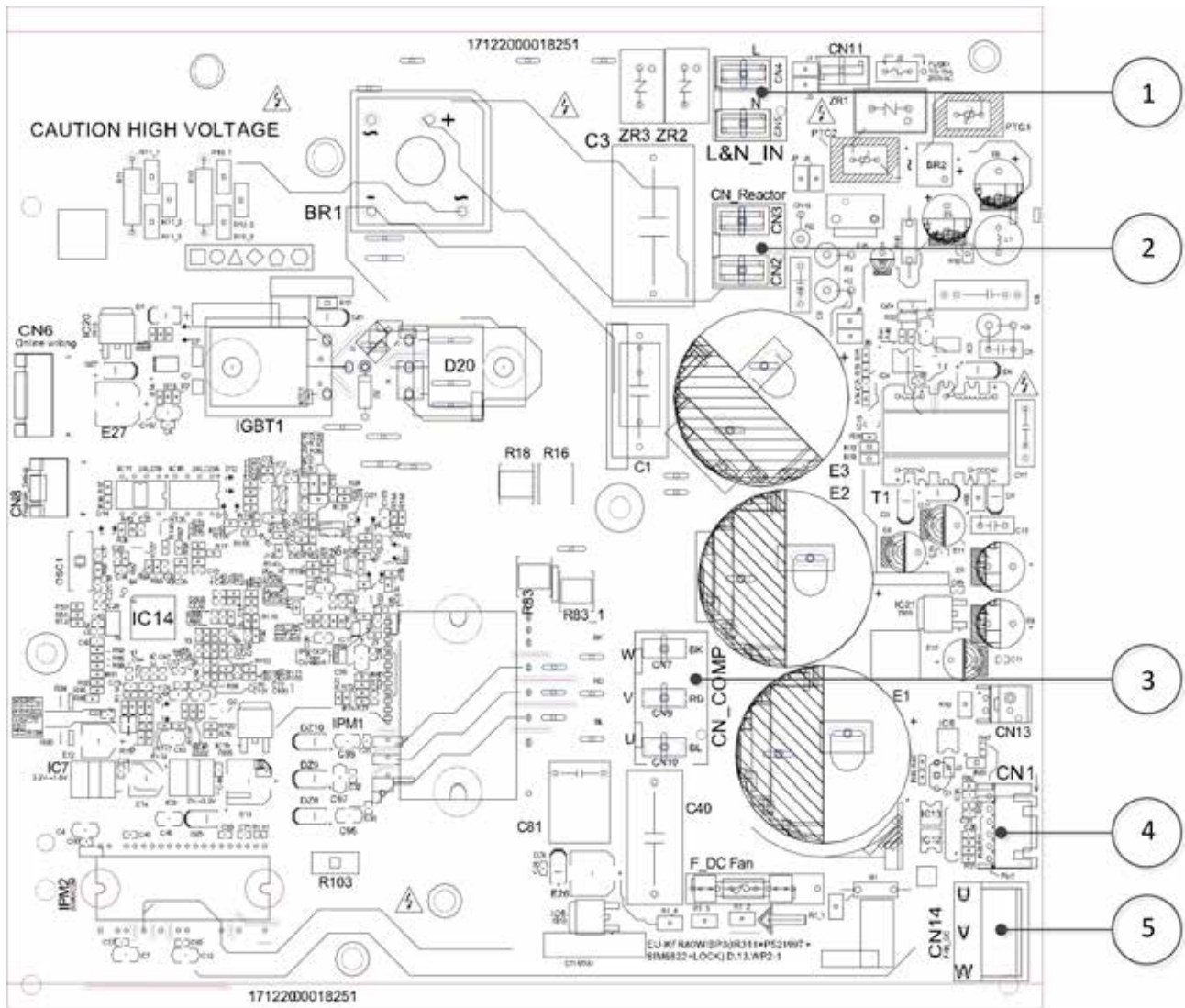

No.	Name	CN#	Meaning
1	CN4	CN4	connect to main board L-Out
	CN5	CN5	connect to main board N-Out
2	CN_Reactor	CN2/CN3	connect to reactor
3	CN_COMP	CN_COMP	connect to compressor
4	CN1	CN1	connect to main board CN21
5	AN_DC	CN14	connect to outdoor DC fan

PCB board of 18DV-1 & 28TV-1

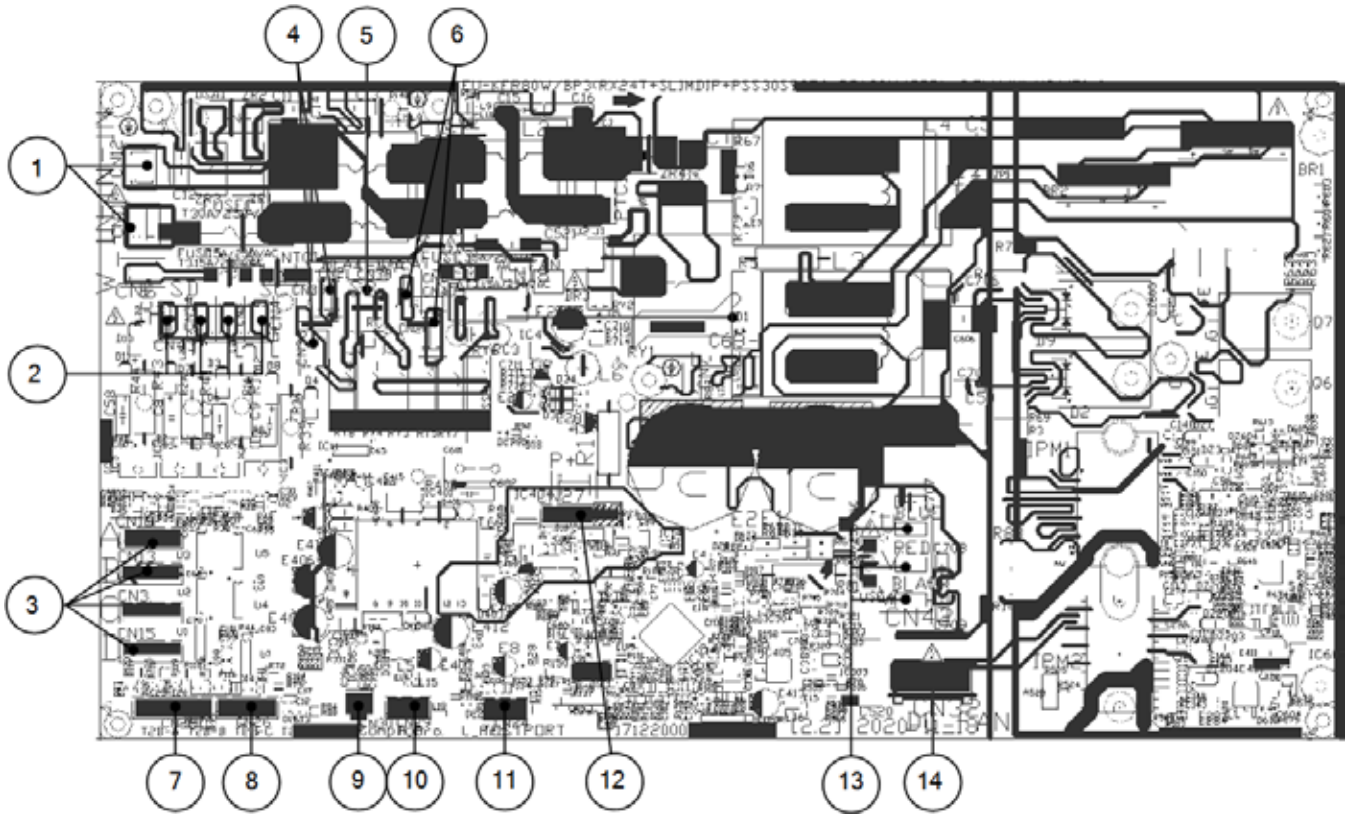

No.	Name	CN#	Meaning
1	Power Supply	CN11	L_in: connect to N-line (208-230V AC input)
		CN12	N_in: connect to L-line (208-230V AC input)
2	Electronic Expansion valve	CN4	connect to Electric Expansion Valve A
		CN2	connect to Electric Expansion Valve B
		CN34	connect to Electric Expansion Valve C
		CN5	connect to Electric Expansion Valve D
3	S-A	CN10	S: connect to indoor unit communication(pin1-pin2: 24VDC Pulse wave; pin2-pin3: 208-230V AC input)
	S-B	CN13	
	S-C	CN3	
	S-D	CN15	
4	HEAT_D	CN21/CN36	connect to chassis heater, 208-230V AC when is ON
5	4-way	CN38	connect to 4 way valve, 208-230V AC when is ON.
6	HEAT_Y	CN8/CN20	connect to compressor heater, 208-230V AC when is ON
7	T2B	CN28	connect to evaporator coil outlet temperature sensor T2B

8	T3 T4 TP	CN26	connect to pipe temp. sensor T3, ambient temp. sensor T4, exhaust temp. sensor TP
9	OLP TEMP. SENSOR	CN30	connect to compressor top temp. sensor (5VDC Pulse wave)
10	H-PRO,L-RPO	CN29	connect to high and low pressure swtich(pin1-pin2&pin3-pin4:5VDC pulse wave)
11	TESTPORT	CN24	used for testing
12	/	CN27	connect to key board CN1

IPM board of 48PV-1 36QV-1

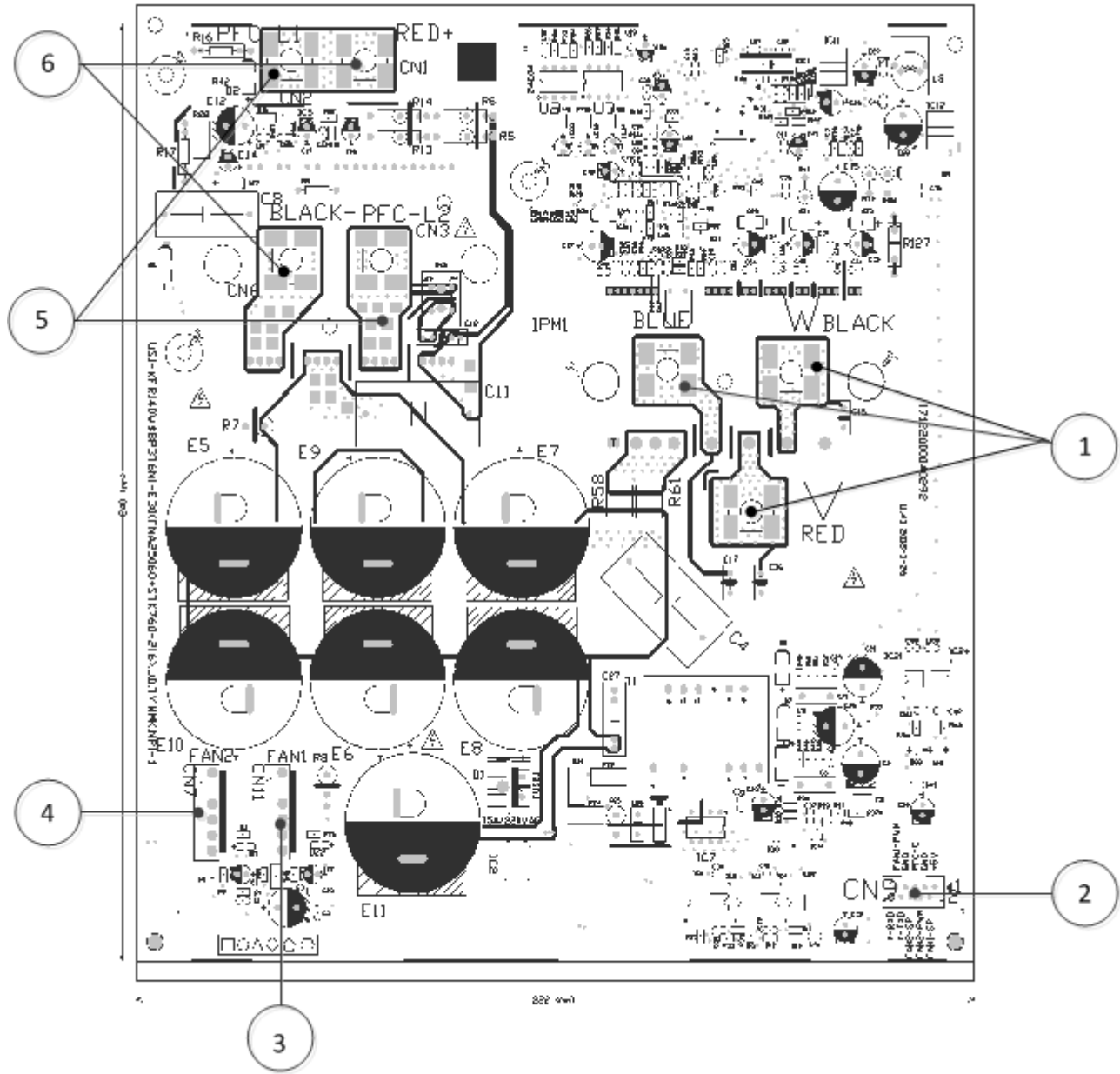

No.	Name	CN#	Meaning
1	W	W	Connect to compressor
	V	V	0V AC (standby)
	U	U	10-200V AC (running)
2	CN9	CN9	Connect to main PCB
3	FAN1	CN11	connect to DC motor driver board
4	FAN2	CN7	
5	PFC-L1	CN2	connect to reactor
	PFC-L2	CN3	
6	PFC-L1	CN6	connect to bridge
	PFC-L2	CN1	

PCB Board of 36QV-1, 48PV-1

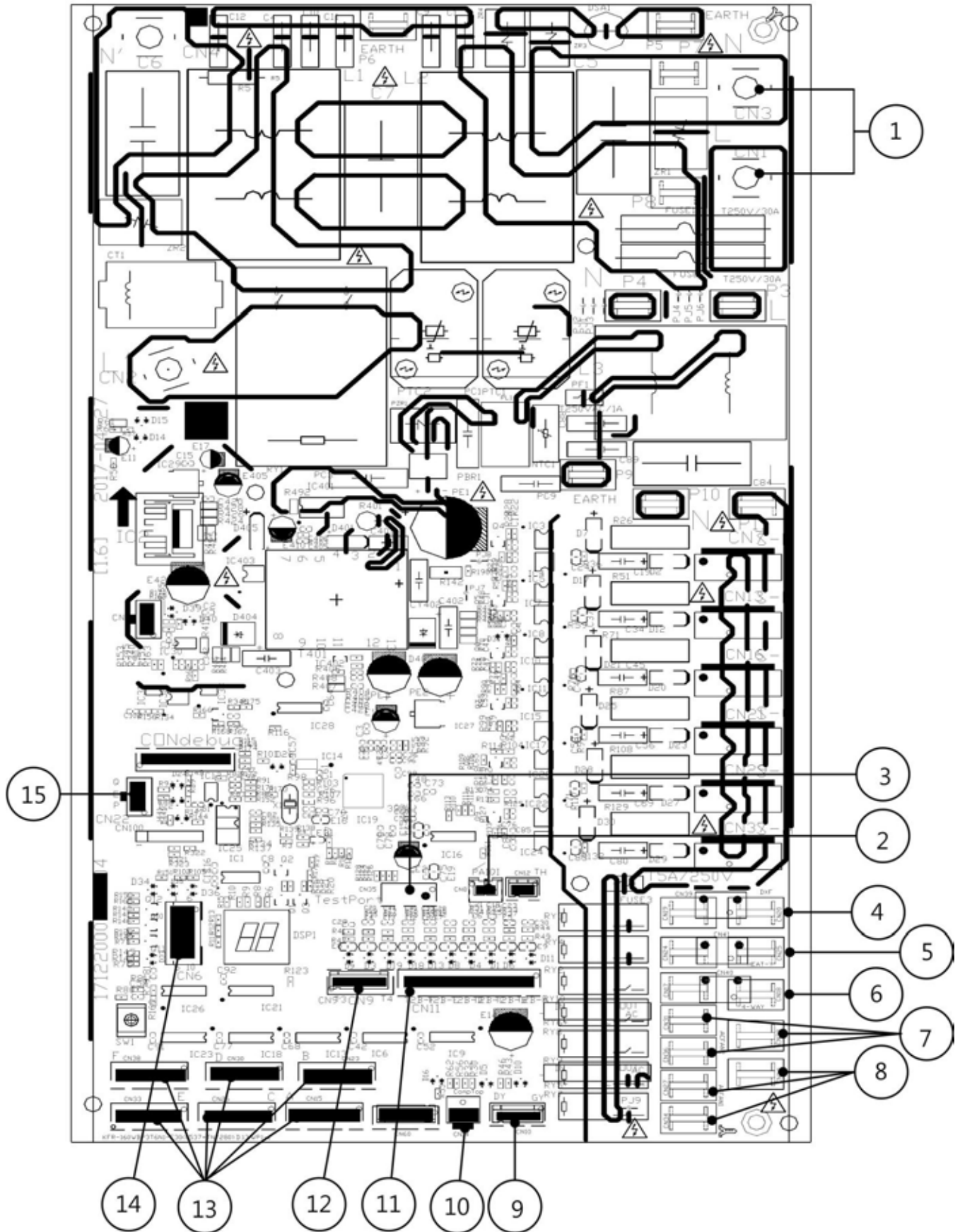

No.	Name	CN#	Meaning
1	Power Supply	CN1	L1_in: connect to L1-line (230V AC input)
		CN3	L2_in: connect to L2-line (230V AC input)
2	TP	CN8	Exhaust temp. sensor TP
3	TESTPORT	CN35	used for testing
4	HEAT1	CN19/CN20	connect to chassis heater, 208-230V AC when is ON
5	HEAT2	CN24/CN25	connect to compressor heater, 208-230V AC when is ON
6	4-WAY	CN17/ CN18	connect to 4 way valve, 208-230V AC when is ON.
7	AC-FAN2	CN28/ CN31/ CN36	connect to AC fan2
8	AC-FAN1	CN27/ CN32/ CN34	connect to AC fan1
9	H-PRO,L-RPO	CN10	connect to high and low pressure swtich(pin1-pin2&pin3-pin4:5VDC pulse wave)
10	OLP TEMP. SENSOR	CN14	connect to compressor top temp. sensor (5VDC Pulse wave)
11	T2B	CN11	connect to pipe temp. sensor T2B
12	T3 T4	CN9	connect to pipe temp. sensor T3, ambient temp. sensor T4
13	Electronic Expansion valve	CN15	connect to Electric Expansion Valve A
		CN23	connect to Electric Expansion Valve B
		CN26	connect to Electric Expansion Valve C
		CN30	connect to Electric Expansion Valve D
		CN33	connect to Electric Expansion Valve E
		CN38	connect to Electric Expansion Valve F
14	/	CN6	connect to IPM&PFC board CN9
15	PQE	CN22	485 communication

## 7. Troubleshooting

### 7.1 Safety

Electricity is stored in capacitors, even when the power supply is shut off. Do not forget to discharge the electricity in the capacitors.

The value of resistance is about 1500 ohm to 2000 ohm

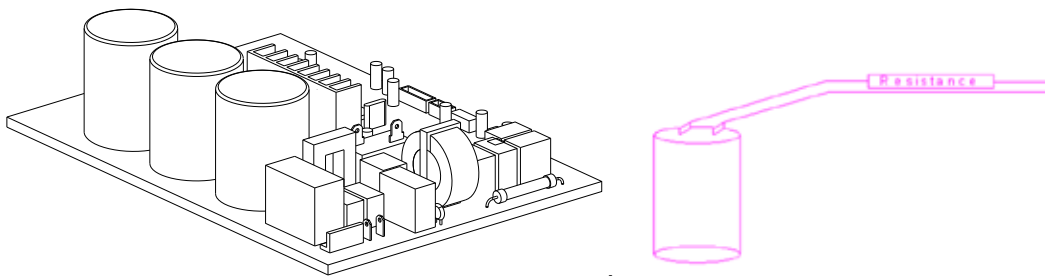

Electrolytic Capacitors

(HIGH VOLTAGE! CAUTION!)

Bulb (25-40W)

The voltage in P3 and P4 in outdoor PCB is high voltage about 310V

The voltage in P5 and P6 in outdoor PCB is high voltage about 310V

## 7.2 Indoor Unit Error Display

### For Old Console series

B-VMH12FU-1;

Operation	Timer	De-frost	Failure
★	X	X	Indoor room temperature sensor (T1 ) malfunction
X	X	★	Evaporator coil temperature sensor (T2) malfunction
X	★	X	Communication malfunction between indoor and outdoor units
●	★	X	Low ambient temperature cut off in heating
★	★	X	Indoor unit EEPROM parameter error
X	★	●	Outdoor fan speed malfunction
★	X	★	Inverter module (IPM) malfunction
★	★	★	Outdoor temperature sensor(coil sensor T3 or ambient temperature sensor T4) malfunction or Outdoor unit EEPROM parameter error
★	●	X	Compressor top high temperature protection (OLP)
★	⊙	X	Compressor drive protection
★	X	●	Indoor units mode conflict
★	●	★	Indoor fan speed malfunction
⊙	X	X	In standby mode
●	⊙	⊙	In force cooling mode

★ flash at 5Hz, ● light, X extinguished, ⊙flash at 0.5Hz

### For Old Duct/Cassette/Floor Ceiling

B-VMH09DU-1, 12DU-1, 18DU-1, 24DU-1

B-VMH09CU-1, 12CU-1, 18CU-1, 24CU-1

B-VMH18UU-1, 24UU-1

Operation	Timer	De-frost	Alarm	Failure	Display	ODU Error code
★	X	X	X	Indoor room temperature sensor (T1 ) malfunction	E0	—
X	X	★	X	Evaporator coil temperature sensor (T2) malfunction	E1	—
X	★	X	X	Communication malfunction between indoor and outdoor units	E2	E2
X	X	X	★	Water-level alarm malfunction	E3	—

★	★	X	X	Indoor unit EEPROM parameter error	E4	—
★	X	X	●	Inverter module (IPM) malfunction	E5	P6
★	●	X	X	Outdoor temperature sensor(coil sensor T3 or ambient temperature sensor T4) malfunction or Outdoor unit EEPROM parameter error	E6	E0,E4
★	●	★	X	Outdoor fan speed malfunction	E7	E8
★	●	●	X	Indoor fan speed malfunction	F5	—
★	●	X	●	Over-voltage or under-voltage protection	P0	E5
★	★	★	X	Current overload protection	P2	P3
★	⊙	X	X	Compressor drive malfunction	P4	—
★	X	●	●	Indoor units mode conflict	P5	—
★ flash at 2.5Hz, ● light, X extinguished, ⊙flash at 0.5Hz						

**All Easy:**

B-VMH06SV-1, 09SV-1, 12SV-1,18SV-1,24SV-1;

Operation lamp	Timer lamp	Display	LED STATUS	ODU Error
★ 1 time	X	E0	Indoor unit EEPROM parameter error	—
★ 2 times	X	E1	Communication malfunction between indoor and outdoor units	E2
★ 4 times	X	E3	Indoor fan speed malfunction	—
★ 5 times	X	E4	Indoor room temperature sensor (T1 ) malfunction	—
★ 6 times	X	E5	Evaporator coil temperature sensor (T2) malfunction	—

★ 9 times	X	EH 0b/Eb	Indoor PCB/Display board communication error	—
★ 8 times	X	EE	Water-level alarm malfunction	—
★ 7 times	X	EC	Refrigerant leakage detection	—
★ 1 time	●	F0	Current overload protection	—
★ 2 times	●	F1	Outdoor ambient temperature sensor (T4 ) malfunction	E4
★ 3 times	●	F2	Condenser coil temperature sensor (T3) malfunction	E4
★ 4 times	●	F3	Compressor discharge temperature sensor (T5) malfunction	E4
★ 5 times	●	F4	Outdoor unit EEPROM parameter error	E0
★ 6 times	●	F5	Outdoor fan speed malfunction	E8
★ 7 times	●	F6	Indoor coil outlet pipe sensor(Located on outdoor unit low pressure valve)	—
★ 8 times	●	F7	Communication malfunction between Cassette optional lift panel and the unit.	—
★ 9 times	●	F8	Cassette optional lift panel malfunction	—
★ 10 times	●	F9	Cassette optional lift panel not closed	—
★ 11 times	●	FA	Communication error between indoor two chips(For A6 Duct)	—
★ 1 time	★	P0	Inverter module (IPM) malfunction	P6
★ 2 times	★	P1	Over-voltage or under-voltage protection	E5
★ 3 times	★	P2	High temperature protection of compressor top(OLP)/ High temperature protection of IPM board	—
★4 times	★	P3	Low ambient temperature protection	LP
★ 5 times	★	P4	Compressor drive malfunction	—
★ 6 times	★	P5 ( <u>    </u> )	Indoor units mode conflict	—
★ 7 times	★	P6	Low pressure protection	P2
★ flash , ● light, X extinguished				

## 7.3 Outdoor Unit Display

### 7.3.1 Outdoor Unit Point Check Function

A check switch is included on the outdoor PCB.

Push SW1 to check the unit's status while running. The digital display shows the following codes each time the SW1 is pushed.

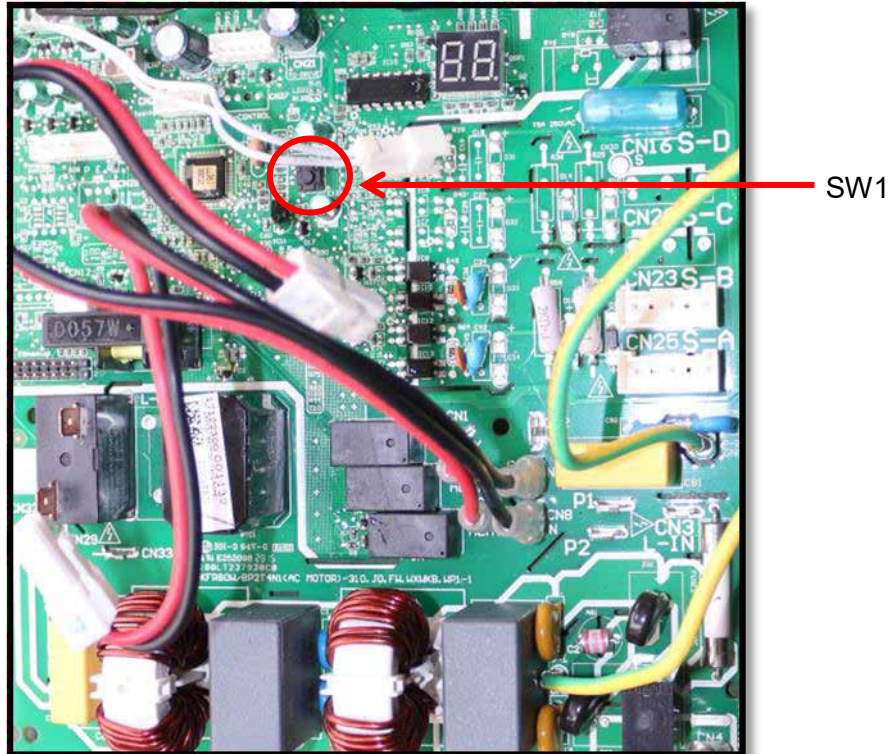

Number of Presses	Display	Remark												
0	Normal display	Displays running frequency, running state, or malfunction code												
1	Quantity of indoor units with working connection	Actual data <table border="1" style="margin-left: 20px;"> <thead> <tr> <th>Display</th> <th>Number of indoor unit</th> </tr> </thead> <tbody> <tr> <td>1</td> <td>1</td> </tr> <tr> <td>2</td> <td>2</td> </tr> <tr> <td>3</td> <td>3</td> </tr> <tr> <td>4</td> <td>4</td> </tr> <tr> <td>5</td> <td>5</td> </tr> </tbody> </table>	Display	Number of indoor unit	1	1	2	2	3	3	4	4	5	5
Display	Number of indoor unit													
1	1													
2	2													
3	3													
4	4													
5	5													
2	Outdoor unit running mode code	Off: 0, Fan only: 1, Cooling: 2, Heating: 3, Forced cooling: 4. Forced defrost: A												
3	Indoor unit A capacity	The capacity unit is horse power. If the indoor unit is not connected, the digital display shows the following: "____" (9K:1HP,12K:1.2HP,18K:1.5HP,24K:2.0HP)												
4	Indoor unit B capacity													
5	Indoor unit C capacity													
6	Indoor unit D capacity													
7	Indoor unit E capacity													
8	Indoor unit A capacity demand code	Norm code*HP (9K: 1HP,12K: 1.2HP,18K: 1.5HP,24K:2.0HP)												
9	Indoor unit B capacity demand code													
10	Indoor unit C capacity demand code													
11	Indoor unit D capacity demand code													
12	Indoor unit E capacity demand code													
13	Outdoor unit amendatory capacity demand code													
14	The frequency corresponding to the total indoor													

	units' amendatory capacity demand			
15	The frequency after the frequency limit			
16	The frequency sending to compressor control chip			
17	Indoor unit A evaporator outlet temperature (T <sub>2B</sub> A)	If the temperature is lower than -9 °C, the digital display shows "-9." If the temperature is higher than 70 °C, the digital display shows "70." If the indoor unit is not connected, the digital display shows: "——"		
18	Indoor unit B evaporator outlet temperature (T <sub>2B</sub> B)			
19	Indoor unit C evaporator outlet temperature (T <sub>2B</sub> C)			
20	Indoor unit D evaporator outlet temperature (T <sub>2B</sub> D)			
21	Indoor unit E evaporator outlet temperature (T <sub>2B</sub> E)			
22	Indoor unit A room temperature (T <sub>1</sub> A)	If the temperature is lower than 0 °C, the digital display shows "0." If the temperature is higher than 50 °C, the digital display shows "50." If the indoor unit is not connected, the digital display shows: "——"		
23	Indoor unit B room temperature (T <sub>1</sub> B)			
24	Indoor unit C room temperature (T <sub>1</sub> C)			
25	Indoor unit D room temperature (T <sub>1</sub> D)			
26	Indoor unit E room temperature (T <sub>1</sub> E)			
27	Indoor unit A evaporator temperature (T <sub>2</sub> A)	If the temperature is lower than -9 °C, the digital display shows "-9." If the temperature is higher than 70 °C, the digital display shows "70." If the indoor unit is not connected, the digital display shows: "——"		
28	Indoor unit B evaporator temperature (T <sub>2</sub> B)			
29	Indoor unit C evaporator temperature (T <sub>2</sub> C)			
30	Indoor unit D evaporator temperature (T <sub>2</sub> D)			
31	Indoor unit E evaporator temperature (T <sub>2</sub> E)			
32	Condenser pipe temperature (T3)			
33	Outdoor ambient temperature (T4)			
34	Compressor discharge temperature (TP)	The display value is between 30–129 °C. If the temperature is lower than 30 °C, the digital display shows "30." If the temperature is higher than 99 °C, the digital display shows single and double digits. For example, if the digital display shows "0.5", the compressor discharge temperature is 105 °C.		
35	AD value of current	The display value is a hex number. For example, the digital display tube shows "Cd", it means AD value is 205.		
36	AD value of voltage			
37	EXV open angle for A indoor unit	Actual data/4. If the value is higher than 99, the digital display shows single and double digits. For example, if the digital display shows "2.0", the EXV open angle is 120×4=480p.		
38	EXV open angle for B indoor unit			
39	EXV open angle for C indoor unit			
40	EXV open angle for D indoor unit			
41	EXV open angle for E indoor unit			
42	Frequency limit symbol	Bit7	Frequency limit caused by IGBT radiator	The display value is a hexadecimal number. For example, the digital display show 2A, then Bit5=1, Bit3=1, and Bit1=1. This means that a frequency limit may be caused by T4, T3, or the current.
		Bit6	Frequency limit caused by PFC	
		Bit5	Frequency limit caused by T4.	
		Bit4	Frequency limit caused by T2.	
		Bit3	Frequency limit caused by T3.	
		Bit2	Frequency limit caused by T5.	
		Bit1	Frequency limit caused by current	
Bit0	Frequency limit caused by voltage			
43	Average value of T2	(Sum T2 value of all indoor units)/(number of indoor units in good connection)		
44	Outdoor unit fan motor state	Off: 0, Super high speed:1, High speed:2, Med speed: 3, Low speed: 4, Breeze:5, Super breeze: 6		
45	The last error or protection code	00 means no malfunction and protection		

46	F indoor unit capacity	
47	F indoor unit capacity demand code	
48	F indoor unit evaporator outlet temperature (T <sub>2B</sub> F)	
49	F indoor unit room temperature (T <sub>1</sub> F)	
50	F indoor unit evaporator temperature (T <sub>2</sub> F)	
51	EXV open angle for F indoor unit	
52	Reason of stop	
53	EVI valve target angle(only for A-VMH48PV-1)	Actual data/4.
54	EVI valve open angle(only for A-VMH48PV-1)	If the value is higher than 99, the digital display tube will show single digit and tens digit.
55	EVI valve angle(only for A-VMH48PV-1)	For example, the digital display tube show "2.0",it means the EXV open angle is 120×4=480p.)

For A-VMH18DV-1

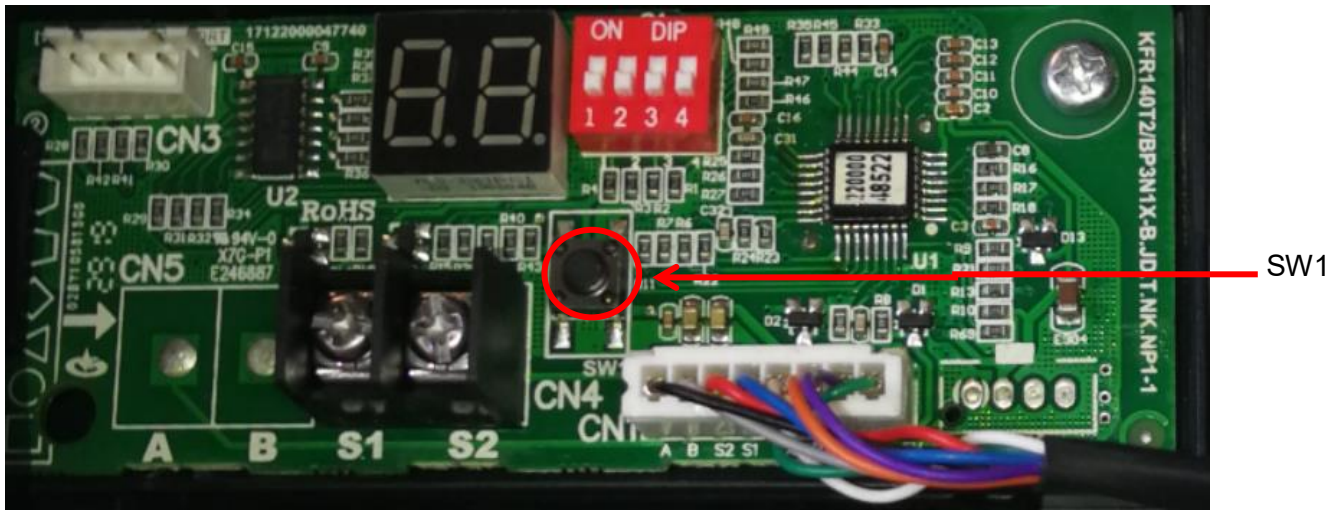

Number of Presses	Display	Remark												
0	Normal display	Displays running frequency, running state, or malfunction code												
1	Quantity of indoor units with working connection	Actual data <table border="1" style="margin-left: 20px;"> <thead> <tr> <th>Display</th> <th>Number of indoor unit</th> </tr> </thead> <tbody> <tr> <td>1</td> <td>1</td> </tr> <tr> <td>2</td> <td>2</td> </tr> <tr> <td>3</td> <td>3</td> </tr> <tr> <td>4</td> <td>4</td> </tr> <tr> <td>5</td> <td>5</td> </tr> </tbody> </table>	Display	Number of indoor unit	1	1	2	2	3	3	4	4	5	5
Display	Number of indoor unit													
1	1													
2	2													
3	3													
4	4													
5	5													
2	Outdoor unit running mode code	Off: 0, Fan only: 1, Cooling: 2, Heating: 3, Forced cooling: 4. Forced defrost: A												
3	Indoor unit A capacity	The capacity unit is horse power. If the indoor unit is not connected, the digital display shows the following: "—" (9K:1HP, 12K:1.2HP, 18K:1.5HP, 24K:2.0HP)												
4	Indoor unit B capacity													
5	Indoor unit C capacity													
6	Indoor unit D capacity													
7	Indoor unit E capacity													

8	Indoor unit A capacity demand code	Norm code*HP (9K: 1HP,12K: 1.2HP,18K: 1.5HP,24K:2.0HP)		
9	Indoor unit B capacity demand code			
10	Indoor unit C capacity demand code			
11	Indoor unit D capacity demand code			
12	Indoor unit E capacity demand code			
13	Outdoor unit amendatory capacity demand code			
14	The frequency corresponding to the total indoor units' amendatory capacity demand			
15	The frequency after the frequency limit			
16	The frequency sending to compressor control chip			
17	Indoor unit A evaporator outlet temperature (T <sub>2B</sub> A)	If the temperature is lower than -9 °C, the digital display shows "-9." If the temperature is higher than 70 °C, the digital display shows "70." If the indoor unit is not connected, the digital display shows: "—"		
18	Indoor unit B evaporator outlet temperature (T <sub>2B</sub> B)			
19	Indoor unit C evaporator outlet temperature (T <sub>2B</sub> C)			
20	Indoor unit D evaporator outlet temperature (T <sub>2B</sub> D)			
21	Indoor unit E evaporator outlet temperature (T <sub>2B</sub> E)			
22	Indoor unit A room temperature (T <sub>1</sub> A)	If the temperature is lower than 0 °C, the digital display shows "0." If the temperature is higher than 50 °C, the digital display shows "50." If the indoor unit is not connected, the digital display shows: "—"		
23	Indoor unit B room temperature (T <sub>1</sub> B)			
24	Indoor unit C room temperature (T <sub>1</sub> C)			
25	Indoor unit D room temperature (T <sub>1</sub> D)			
26	Indoor unit E room temperature (T <sub>1</sub> E)			
27	Indoor unit A evaporator temperature (T <sub>2</sub> A)	If the temperature is lower than -9 °C, the digital display shows "-9." If the temperature is higher than 70 °C, the digital display shows "70." If the indoor unit is not connected, the digital display shows: "—"		
28	Indoor unit B evaporator temperature (T <sub>2</sub> B)			
29	Indoor unit C evaporator temperature (T <sub>2</sub> C)			
30	Indoor unit D evaporator temperature (T <sub>2</sub> D)			
31	Indoor unit E evaporator temperature (T <sub>2</sub> E)			
32	Condenser pipe temperature (T <sub>3</sub> )			
33	Outdoor ambient temperature (T <sub>4</sub> )			
34	Compressor discharge temperature (TP)	The display value is between 30–129 °C. If the temperature is lower than 30 °C, the digital display shows "30." If the temperature is higher than 99 °C, the digital display shows single and double digits. For example, if the digital display shows "0.5", the compressor discharge temperature is 105 °C.		
35	AD value of current	The display value is a hex number. For example, the digital display tube shows "Cd", it means AD value is 205.		
36	AD value of AC voltage			
37	AD value of DC voltage			
38	EXV open angle for A indoor unit	Actual data/4. If the value is higher than 99, the digital display shows single and double digits. For example, if the digital display shows "2.0", the EXV open angle is 120×4=480p.		
39	EXV open angle for B indoor unit			
40	EXV open angle for C indoor unit			
41	EXV open angle for D indoor unit			
42	EXV open angle for E indoor unit			
43	MVI valve open angle			
44	EVI valve open angle			
45	Frequency limit symbol	Bit7	Reserve	The display value is a hexadecimal number. For example, the digital display
		Bit6	Frequency limit caused by voltage	
		Bit5	Frequency limit caused by current.	

		Bit4	Reserve.	show 2A, then Bit5=1, Bit3=1, and Bit1=1. This means that a frequency limit may be caused by current, IPM or T3.
		Bit3	Frequency limit caused by IPM.	
		Bit2	Frequency limit caused by T5.	
		Bit1	Frequency limit caused by T3	
		Bit0	Frequency limit caused by T2	
46	T2B fault	00:No fault,01:T2B-A fault, ,02:T2B-B fault ,03:T2B-C fault,04:T2B-D fault, 05:T2B-E fault, 06:T2B-F fault(The display priority is A-B-C-D-E-F)		
47	Average value of T2	(Sum T2 value of all indoor units)/(number of indoor units in good connection)( The heating is the average value of T2, and the cooling is the average value of T2B)		
48	Outdoor unit fan motor state	Off: 0, Super ultra high speed:1, Super high speed:2, High speed:3, Med speed: 4, Low speed: 5, Breeze:6, Super breeze: 7		
49	Reason of stop			

### 7.3.2 Outdoor Unit Digital Display

A digital display is featured on the outdoor PCB.

The LED displays different codes in the following situations:

- Standby: “- -.”
- Compressor operation: the running frequency.
- Defrosting mode: “dF” or alternative displays between running frequency and “dF” (ach appears for 0.5s.)
- Forced cooling mode: the LED displays “FC” or alternative displays between running frequency and “FC” (each appears for 0.5s).
- Compressor pre-heating: “PH” or alternative displays between running frequency and “PH” (each appears for 0.5s.)
- Oil return process: “RO” or alternative displays between running frequency and “RO” (each appears for 0.5s.)
- Low ambient cooling mode: “LC” or alternative displays between running frequency and “LC” (each appears for 0.5s.)
- PFC module protection occurs three times within 15 minutes: “E6” or alternates between displays of running frequency and “E6” (each appears for 0.5s.)
- In protection or malfunction, the LED displays an error code or protection code. “PH”, “RO”, “LC”, “E6” are not suitable for A-VMH18DV-1, A-VMH28TV-1

### 7.3.3 Outdoor unit error display

For other models,

Display	LED STATUS	New indoor Error
E0	Outdoor unit EEPROM parameter error	F4
E2	Communication malfunction between indoor and outdoor units	E1
E3	Communication malfunction between IPM board and outdoor main control board	—
E4	Outdoor temperature sensor (coil sensor T3, ambient sensor T4, Compressor discharge sensor T5、 indoor coil outlet pipe sensor T2B) malfunction	F2/F1/F3/F6
E5	Over-voltage or under-voltage protection	P1
E6	PFC module protection	—
E8	Outdoor fan speed malfunction	F5
F1	No. A Indoor unit coil outlet temp. sensor malfunction	—
F2	No. B Indoor unit coil outlet temp. sensor malfunction	—
F3	No. C Indoor unit coil outlet temp. sensor malfunction	—
F4	No. D Indoor unit coil outlet temp. sensor malfunction	—
F5	No. E Indoor unit coil outlet temp. sensor malfunction	—
F6	No. F Indoor unit coil outlet temp. sensor malfunction	—
P0	High temperature protection of compressor top	P2
P1	High pressure protection	P6
P2	Low pressure protection	P6
P3	Current overload protection	F0
P4	Temperature protection of compressor discharge	—
P5	Condenser high temperature protection	—
P6	Inverter module (IPM) malfunction	P0
LP	Low ambient temperature protection	—
Ed	Communication malfunction between adapter board and outdoor main control board(only for A-VMH48PV-1)	—

**18DV-1, 28TV-1, 36QV-1, 48PV-1**

<b>Display</b>	<b>LED STATUS</b>
EC 51	Outdoor EEPROM malfunction
EL 01	Indoor / outdoor units communication error
PC 40	Communication malfunction between IPM board and outdoor main board
PC 08	Outdoor overcurrent protection
PC 10	Outdoor unit low AC voltage protection
PC 11	Outdoor unit main control board DC bus high voltage protection
PC 12	Outdoor unit main control board DC bus high voltage protection /341 MCE error
PC 00	IPM module protection
PC 0F	PFC module protection
EC 71	Over current failure of outdoor DC fan motor
EC 72	Lack phase failure of outdoor DC fan motor
EC 07	Outdoor fan speed has been out of control
PC 43	Outdoor compressor lack phase protection
PC 44	Outdoor unit zero speed protection
PC 45	Outdoor unit IR chip drive failure
PC 46	Compressor speed has been out of control
PC 49	Compressor overcurrent failure
PC 30	High pressure protection (For M4OB-36HFN8-Q, M5OD-42HFN8-Q, M5OE-42HFN8-Q)
PC 31	Low pressure protection (For M4OB-36HFN8-Q, M5OD-42HFN8-Q, M5OE-42HFN8-Q)
PC 0A	High temperature protection of condenser
PC 06	Temperature protection of compressor discharge
PC 0L	Low ambient temperature protection
PC 02	Top temperature protection of compressor
EC 52	Condenser coil temperature sensor T3 is in open circuit or has short circuited
EC 53	Outdoor room temperature sensor T4 is in open circuit or has short circuited
EC 54	Compressor discharge temperature sensor TP is in open circuit or has short circuited
EC 56	Evaporator coil outlet temperature sensor T2B is in open circuit or has short circuited
EC 50	Open or short circuit of outdoor unit temperature sensor(T3,T4.T5)

## 7.4 Diagnosis and Solution

### 7.4.1 Indoor unit trouble shooting

#### 7.4.1.1 Indoor unit EEPROM parameter error diagnosis and solution.

<b>Malfunction conditions</b>	Indoor or outdoor PCB main chip does not receive feedback from EEPROM chip.
<b>Potential causes</b>	<ul style="list-style-type: none"><li>● Installation mistake</li><li>● Faulty PCB</li></ul>

#### Trouble shooting:

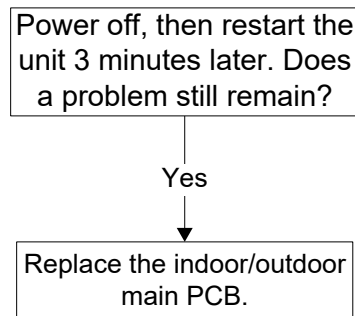

EEPROM: a type of read-only memory. The contents can be erased and reprogrammed using a pulsed voltage. To locate the EEPROM chip,.

### 7.4.1.2 Communication malfunction between indoor and outdoor units diagnosis and solution.

<b>Malfunction conditions</b>	If indoor unit does not receive the feedback from outdoor unit during 120 seconds.
<b>Potential causes</b>	<ul style="list-style-type: none"><li>● Wiring mistake</li><li>● Faulty indoor or outdoor PCB</li></ul>

**Trouble shooting:**

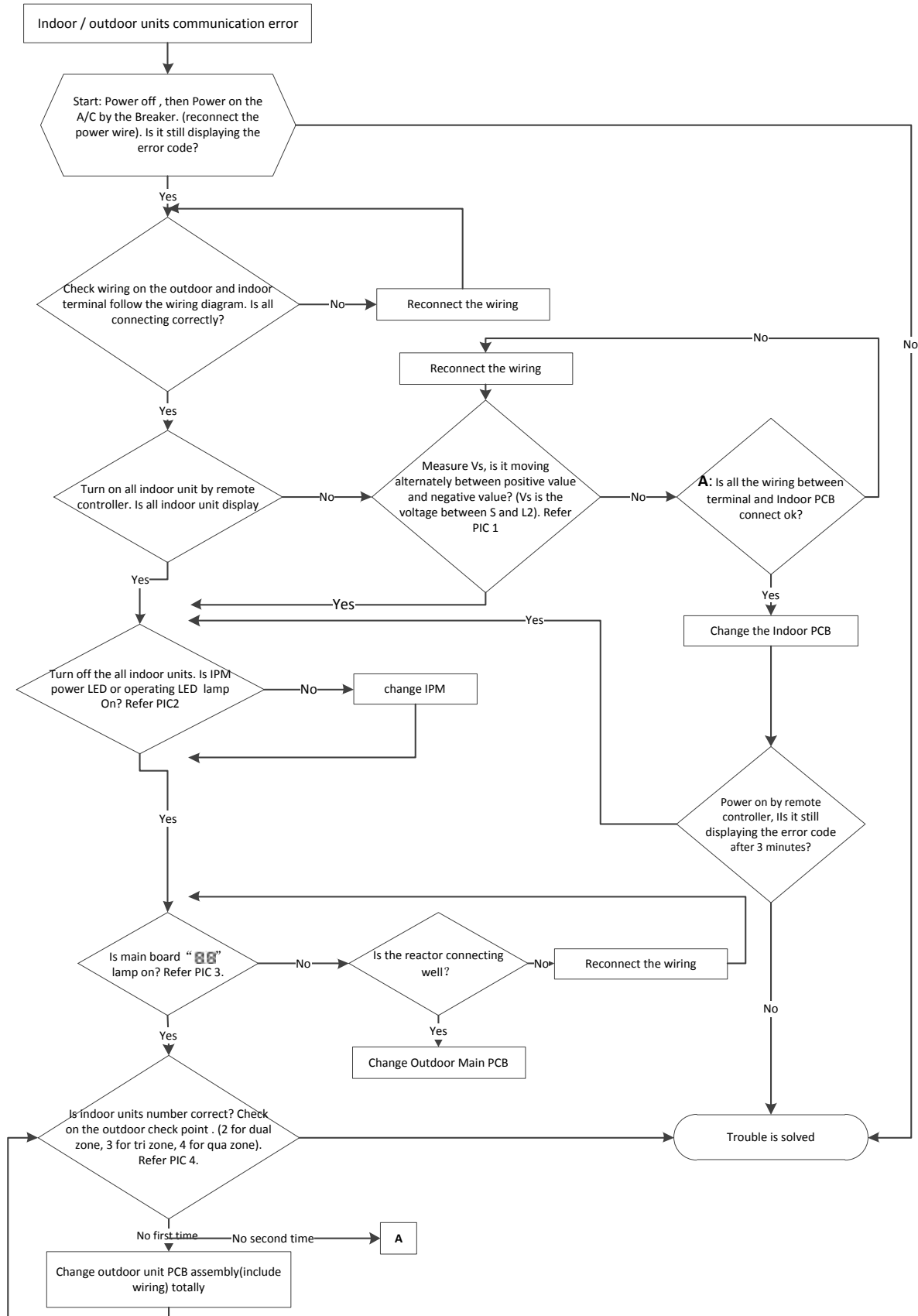



Pic 1: Use a multimeter to test the DC voltage between 2(old: L2) port and S port of outdoor unit. The red pin of multimeter connects with 2 (old: L2) port while the black pin is for S port.

When AC is normal running, the voltage will move alternately between positive value and negative value.

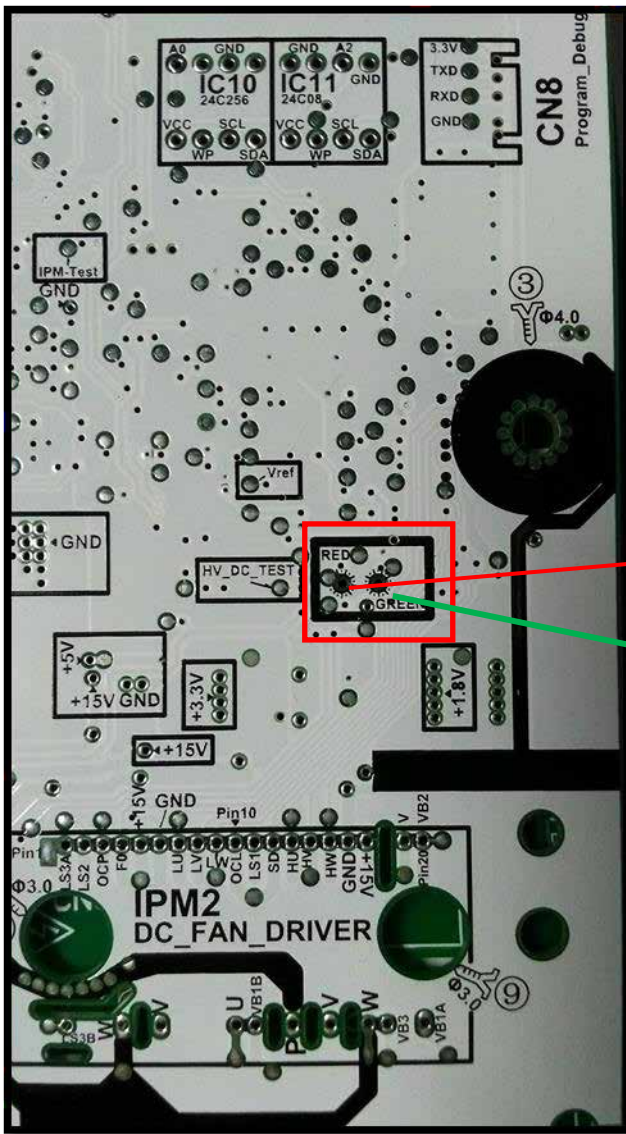

Pic 2: IPM (for 2 zone/ 3-zone)

Operating

Standby

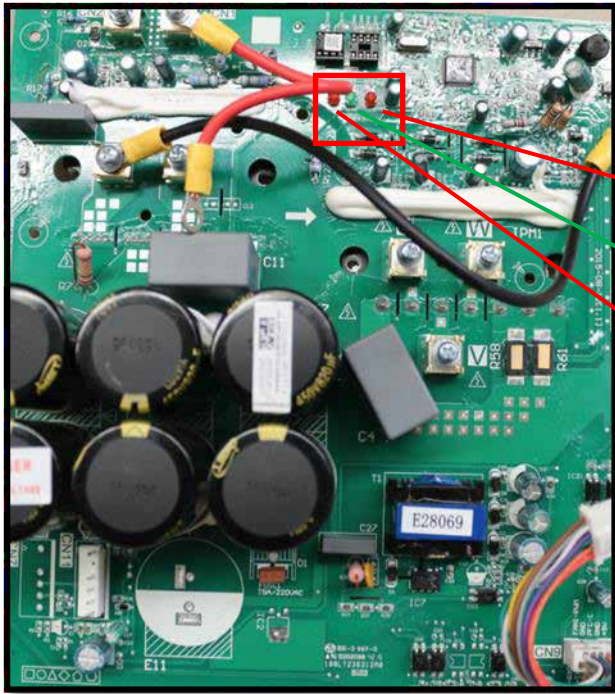

Pic 2: IPM (for 4 zone&5 zone)

- Operating
- Standby
- Power



PIC3: Main board LED when power on and unit standby.

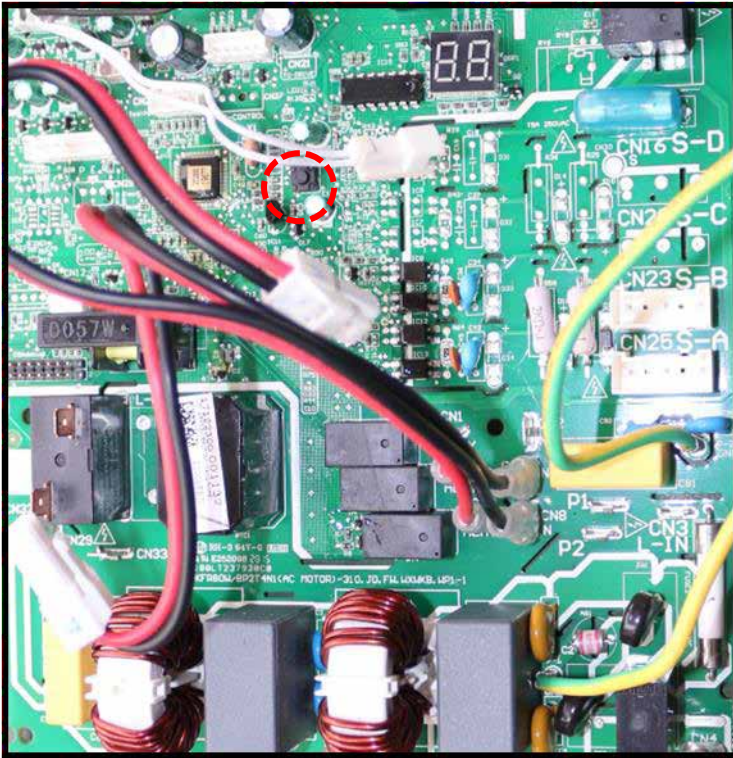

PIC 4: Check point button, press 1 time for check how many indoor units are connected.

### 7.4.1.3 Zero-crossing signal detection error diagnosis and solution.

<b>Malfunction conditions</b>	When PCB does not receive zero crossing signal feedback for 4 minutes or the zero crossing signal time interval is abnormal.
<b>Potential causes</b>	<ul style="list-style-type: none"> <li>● Connection mistake</li> <li>● Faulty PCB</li> </ul>

#### Trouble shooting:

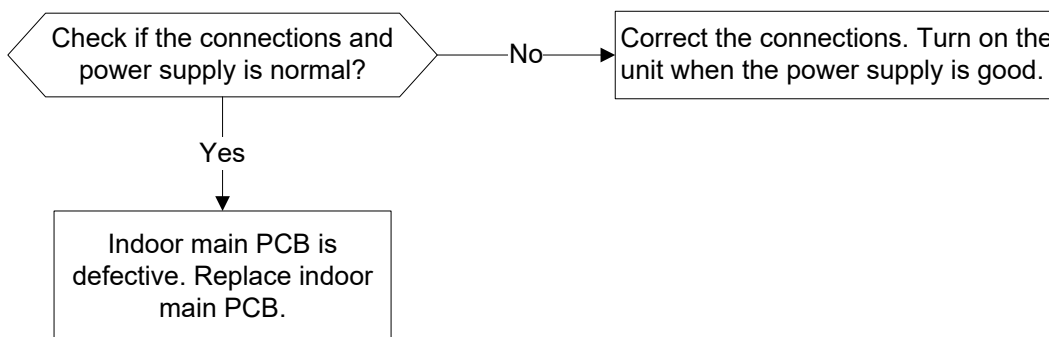

### 7.4.1.4 Indoor fan speed malfunction diagnosis and solution.

<b>Malfunction conditions</b>	When indoor fan speed is too low (300RPM) for a certain period of time, the unit ceases operation and the LED displays a failure code.
<b>Potential causes</b>	<ul style="list-style-type: none"> <li>● Wiring mistake</li> <li>● Faulty fan assembly</li> <li>● Faulty fan motor</li> <li>● Faulty PCB</li> </ul>

**Trouble shooting:**

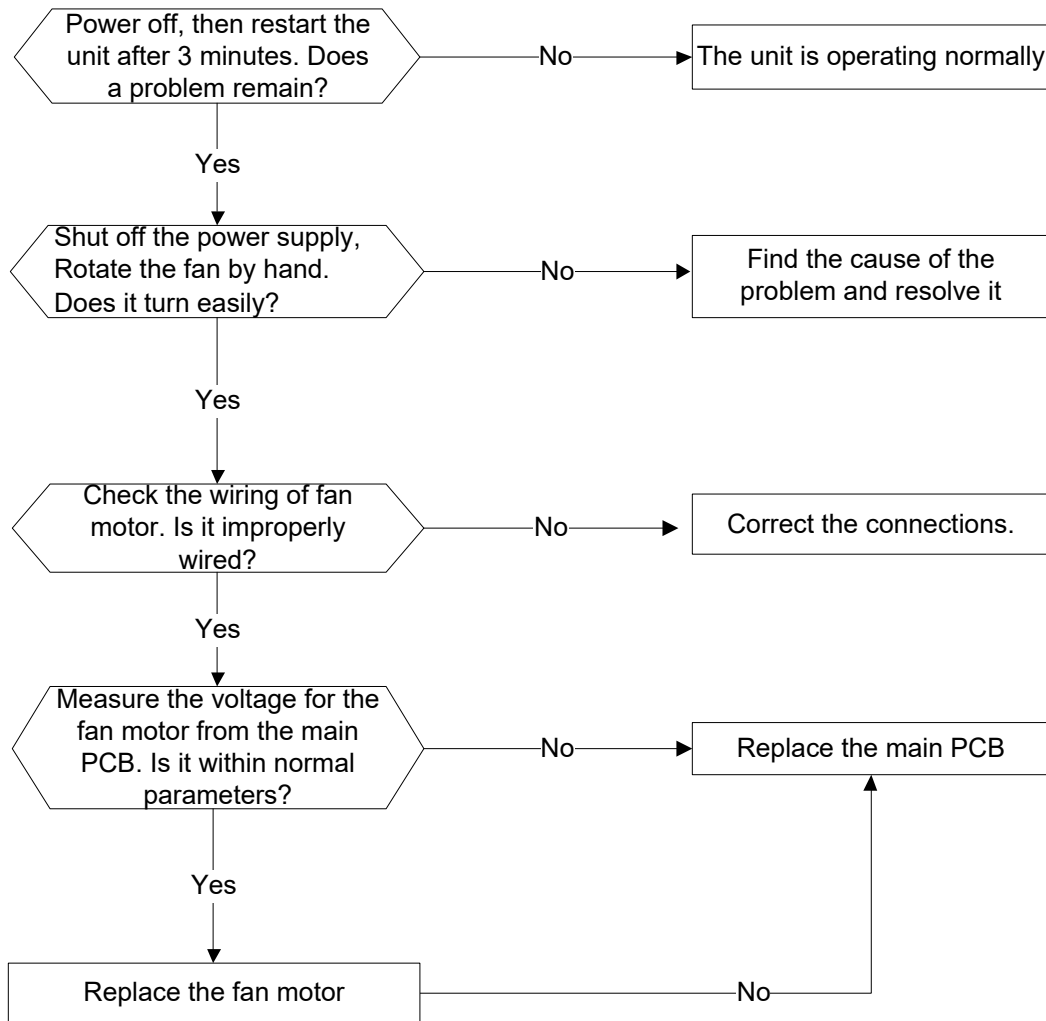

Index 1:

1: Indoor AC fan motor

Power on and set the unit running in fan mode at high fan speed. After running for 15 seconds, measure the voltage of pin1 and pin2. If the value of the voltage is less than 100V (208~240V power supply) or 50V (115V power supply), the PCB must have problems and need to be replaced.

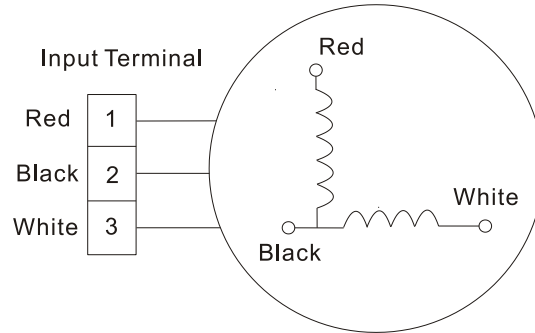

2. Indoor DC fan motor (control chip is inside fan motor)

Power on and when the unit is in standby, measure the voltage of pin1-pin3, pin4-pin3 in fan motor connector. If the value of the voltage is not in the range showing in below table, the PCB must have problems and need to be replaced.

For other models:

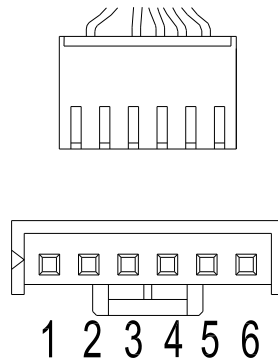

DC motor voltage input and output

NO.	Color	Signal	Voltage
1	Red	Vs/Vm	200V~380V
2	---	---	---
3	Black	GND	0V
4	White	Vcc	13.5-16.5V
5	Yellow	Vsp	0~6.5V
6	Blue	FG	13.5-16.5V

### 7.4.1.5 Temperature sensor malfunction diagnosis and solution.

<b>Malfunction conditions</b>	If the sampling voltage is lower than 0.06V or higher than 4.94V, the LED displays a failure.
<b>Potential causes</b>	<ul style="list-style-type: none"> <li>● Wiring mistake</li> <li>● Faulty sensor</li> <li>● Faulty PCB</li> </ul>

**Trouble shooting:**

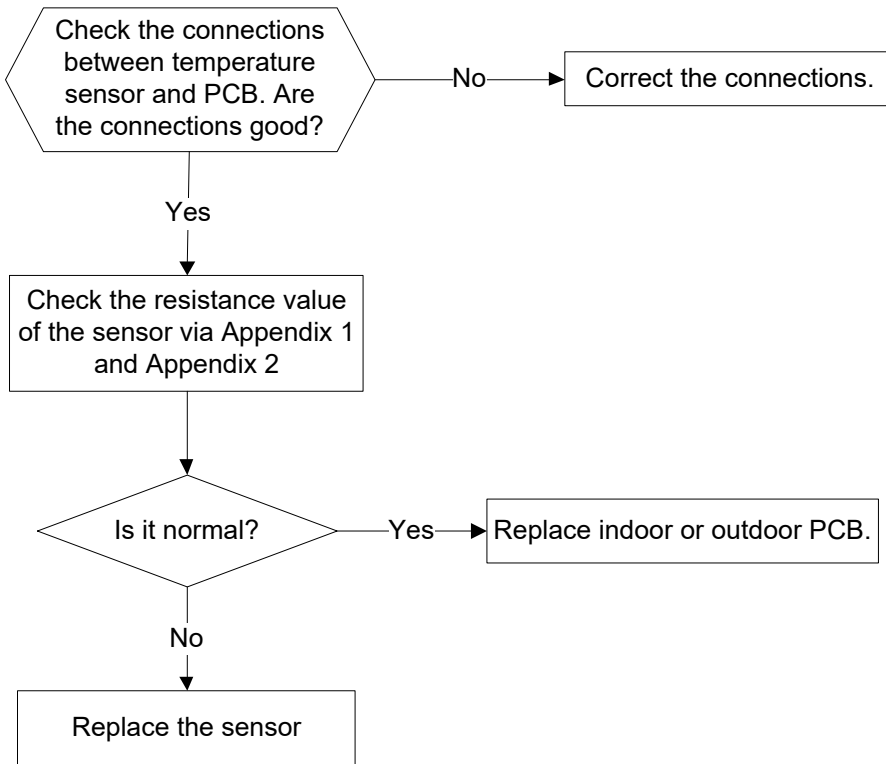

#### 7.4.1.6 Inverter module (IPM) malfunction diagnosis and solution.

<b>Malfunction conditions</b>	When the voltage signal that IPM send to compressor drive chip is abnormal, the display LED will show “P6” and AC will turn off.
<b>Potential causes</b>	<ul style="list-style-type: none"><li>● Wiring mistake</li><li>● IPM malfunction</li><li>● Faulty outdoor fan assembly</li><li>● Compressor malfunction</li><li>● Faulty outdoor PCB</li></ul>

**Trouble shooting:**

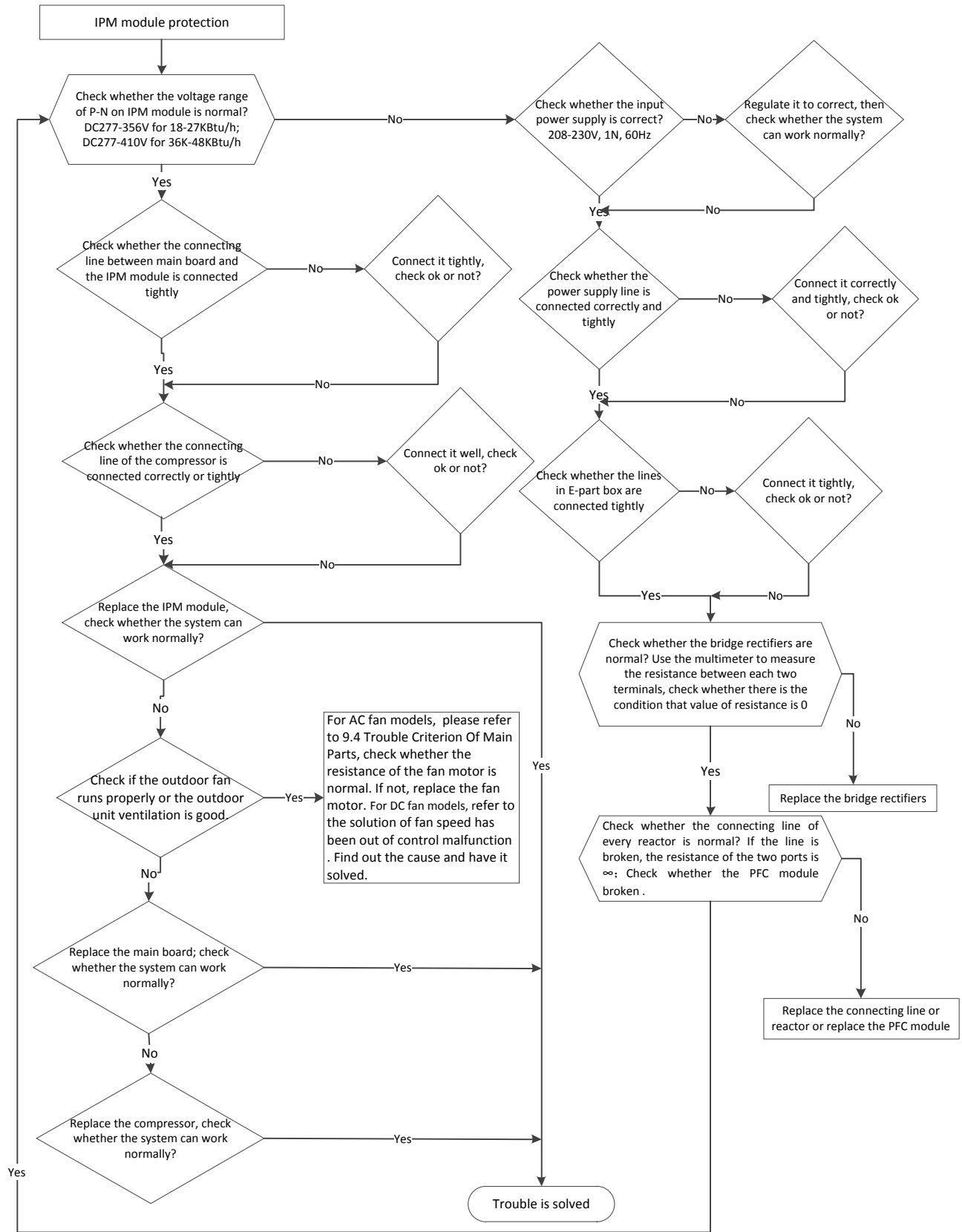

**7.4.1.7 Over-voltage or under-voltage protection diagnosis and solution.**

**Outdoor unit low AC voltage protection**

**Outdoor unit main control board DC bus high voltage protection**

**Outdoor unit main control board DC bus high voltage protection /341 MCE error**

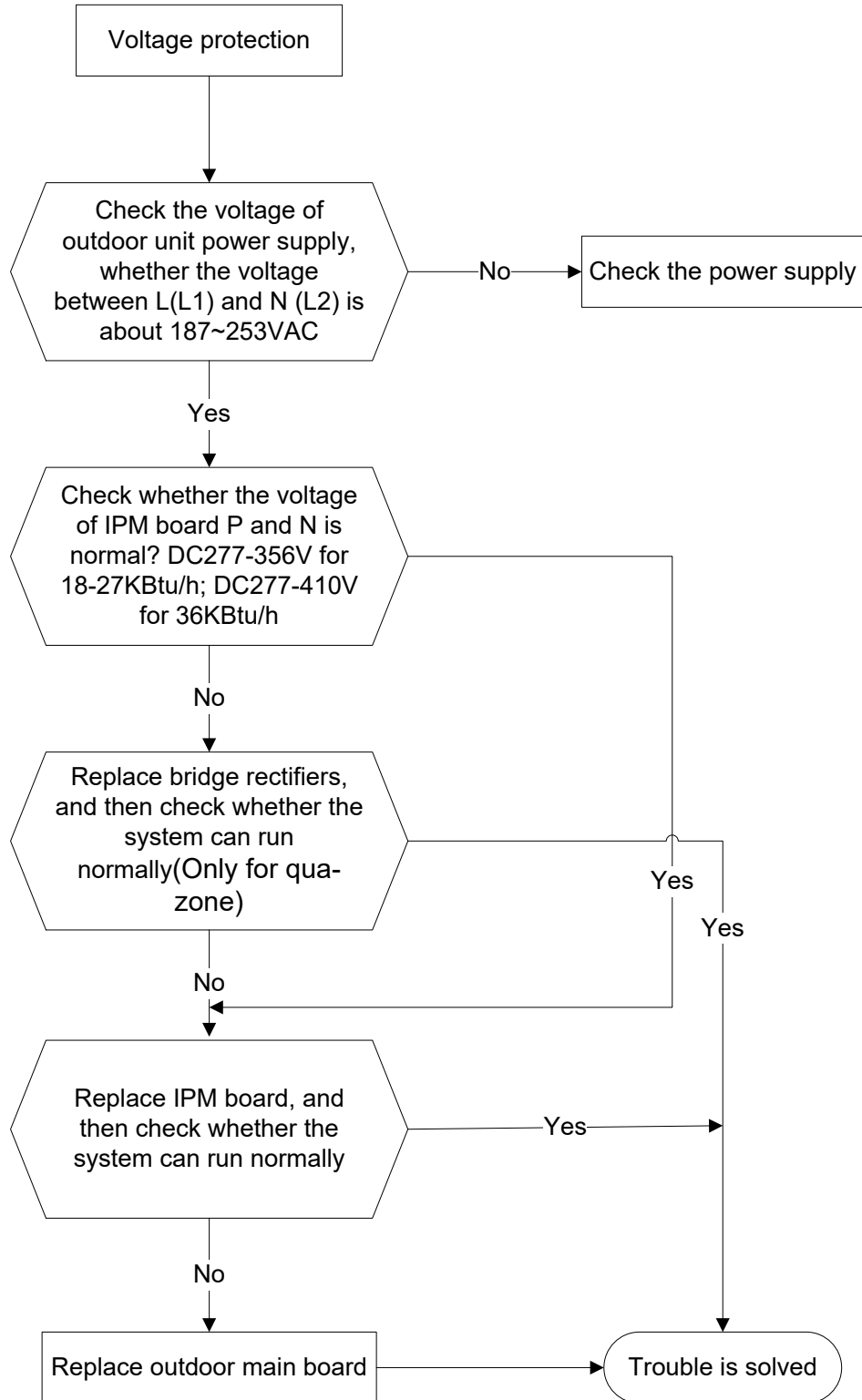

### 7.4.1.8 Compressor drive malfunction diagnosis and solution

The trouble shooting is same with one of IPM module protection.

### 7.4.1.9 Water-level alarm malfunction diagnosis and solution

<b>Malfunction conditions</b>	If the sampling voltage is not 5V, the LED will display the failure code.
<b>Potential causes</b>	<ul style="list-style-type: none"> <li>● Wiring mistakes</li> <li>● Faulty water-level switch</li> <li>● Faulty water pump</li> <li>● Faulty indoor PCB</li> </ul>

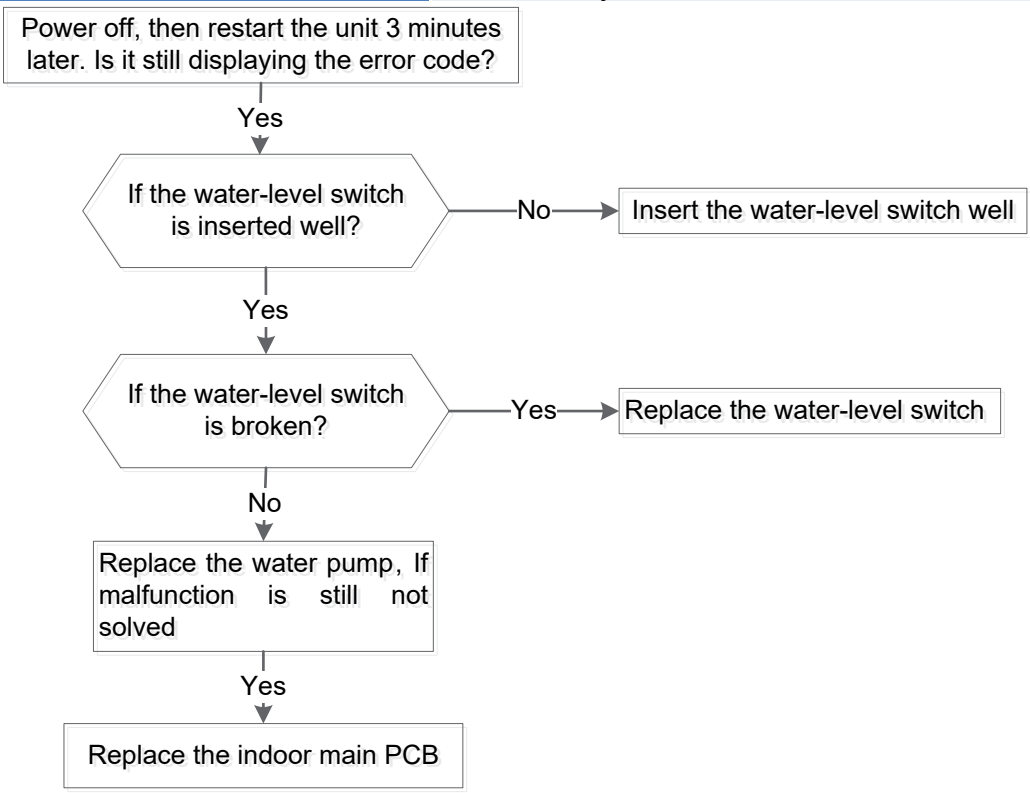

### 7.4.1.10 Indoor units mode conflict

<b>Error Code</b>	<b>P5(old model) or - -(new model)</b>
<b>Malfunction conditions</b>	The indoor units cannot work cooling mode and heating at same time. Heating mode has a priority.
<b>Potential causes</b>	<ul style="list-style-type: none"> <li>● Suppose Indoor unit A working in cooling mode or fan mode, and indoor unit B is set to heating mode, then A will change to off and B will work in heating mode.</li> <li>● Suppose Indoor unit A working in heating mode, and indoor unit B is set to cooling mode or fan mode, then B will change to stand by and A will be no change.</li> </ul>

	Cooling mode	Heating Mode	Fan	Off
Cooling mode	No	Yes	No	No
Heating Mode	Yes	No	Yes	No
Fan	No	Yes	No	No
Off	No	No	No	No

No: No mode conflict;

Yes: Mode conflict

### 7.4.1.11 High temperature protection of IPM board diagnosis and solution

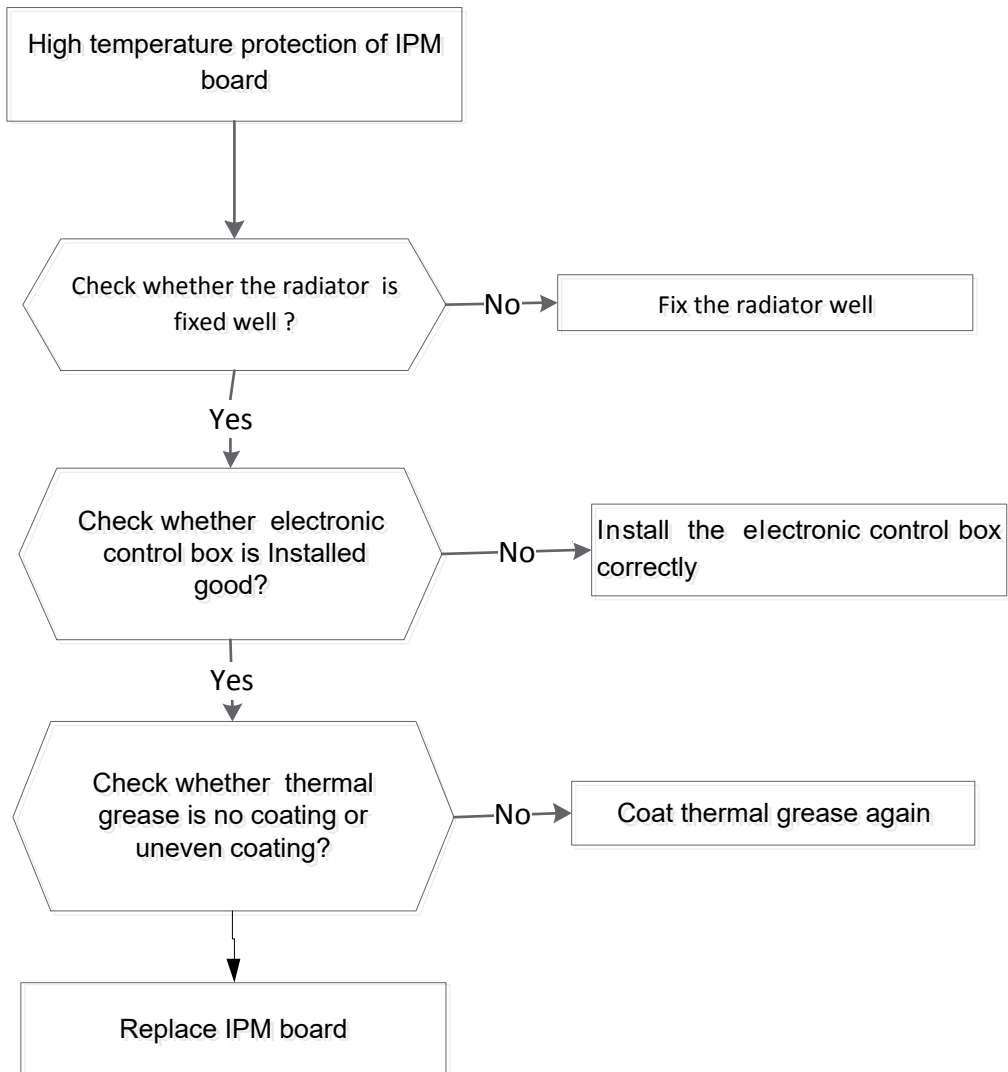

### 7.4.1.12 Communication error between the indoor PCB and display board

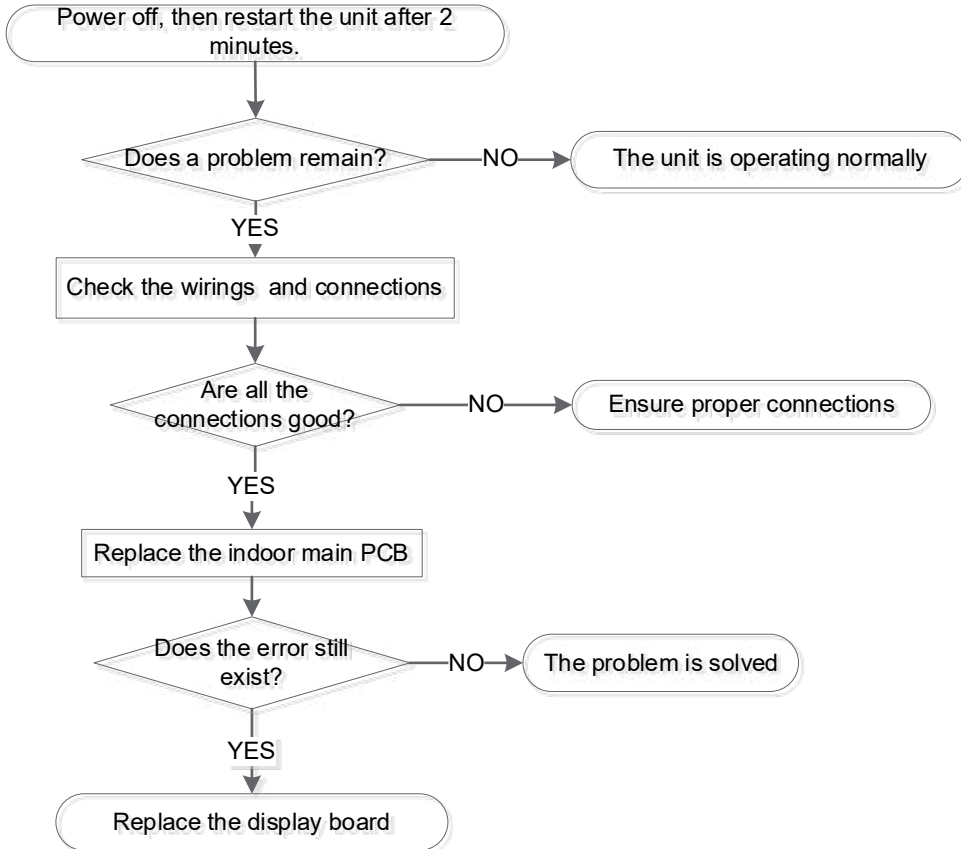

### 7.4.1.13 Refrigerant Leakage Detection

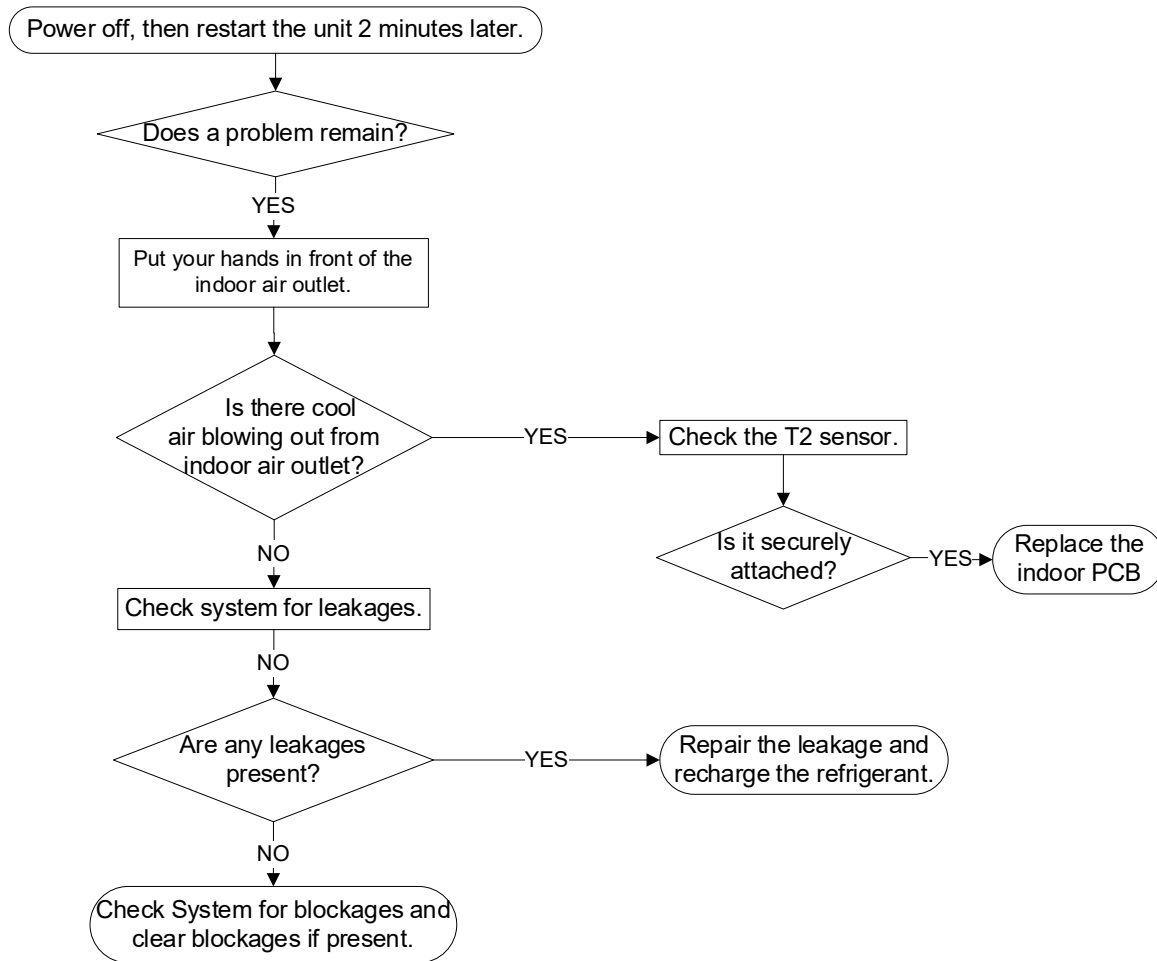

### 7.4.1.14 Communication malfunction between indoor two chips

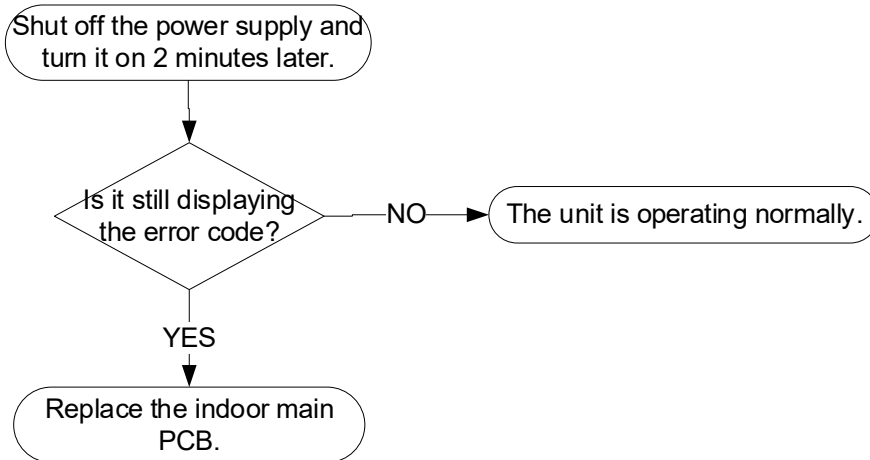

## 7.4.2 Outdoor unit trouble shooting

### 7.4.2.1 E0/ EC 51 (Outdoor unit EEPROM parameter error) diagnosis and solution

<b>Error Code</b>	<b>E0/ EC 51</b>
<b>Malfunction conditions</b>	PCB main chip does not receive feedback from EEPROM chip
<b>Potential causes</b>	<ul style="list-style-type: none"> <li>● Installation mistake</li> <li>● Faulty PCB</li> </ul>

Trouble shooting:

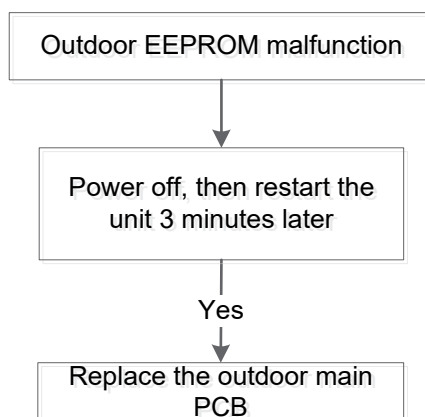

EEPROM: a type of read-only memory. The contents can be erased and reprogrammed using a pulsed voltage.

refer to the following photos.

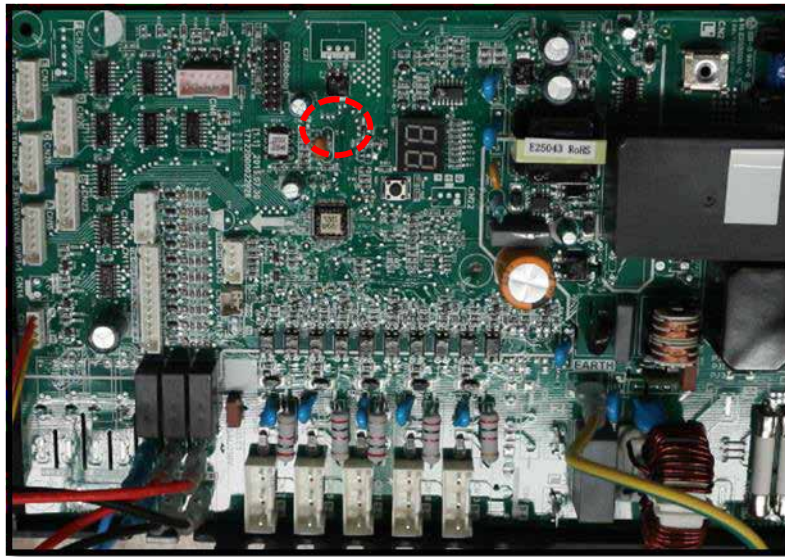

**7.4.2.2 E2/ EL 01 (Communication malfunction between indoor and outdoor units) diagnosis and solution.**

<b>Error Code</b>	<b>E2/ EL 01</b>
<b>Malfunction conditions</b>	Indoor unit does not receive the feedback from outdoor unit during 120 seconds or outdoor unit does not receive the feedback from any one indoor unit during 180 seconds.
<b>Potential causes</b>	<ul style="list-style-type: none"> <li>● Wiring mistake</li> <li>● Faulty Indoor or outdoor PCB</li> </ul>

**Trouble shooting:**

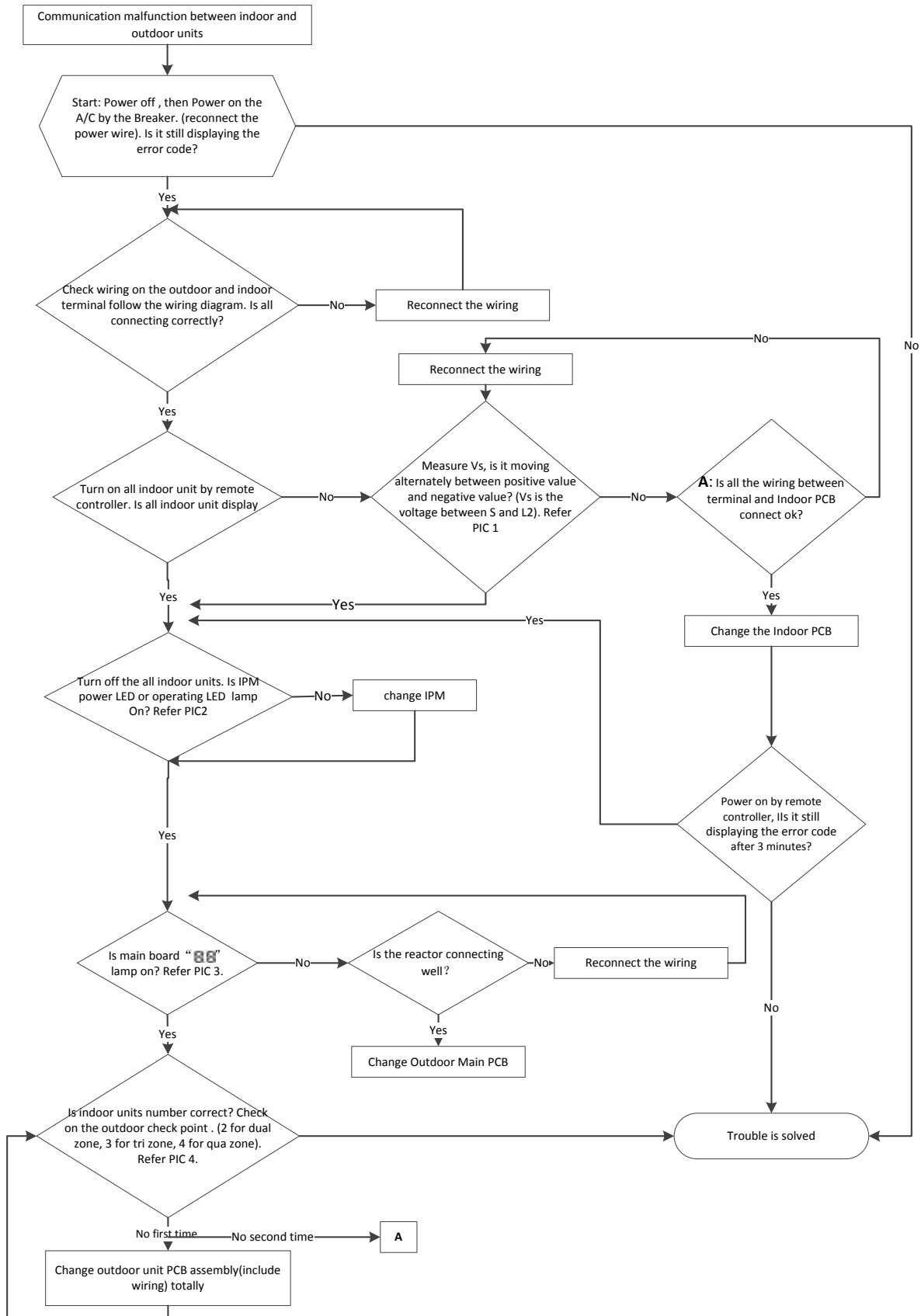



Pic 1: Use a multimeter to test the DC voltage between 2(old: L2) port and 3 port of outdoor unit. The red pin of multimeter connects with 2 (old: L2) port while the black pin is for 3 port.

When AC is normal running, the voltage will move alternately between positive value and negative value.

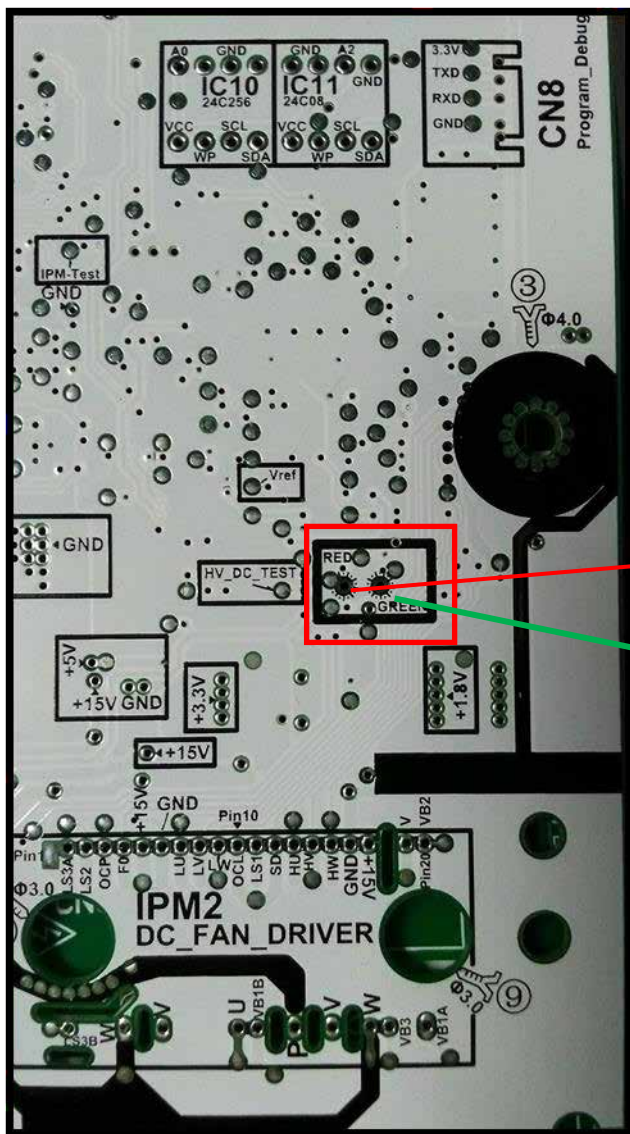

Pic 2: IPM board (for 2 zone/ 3-zone)

Operating

Standby

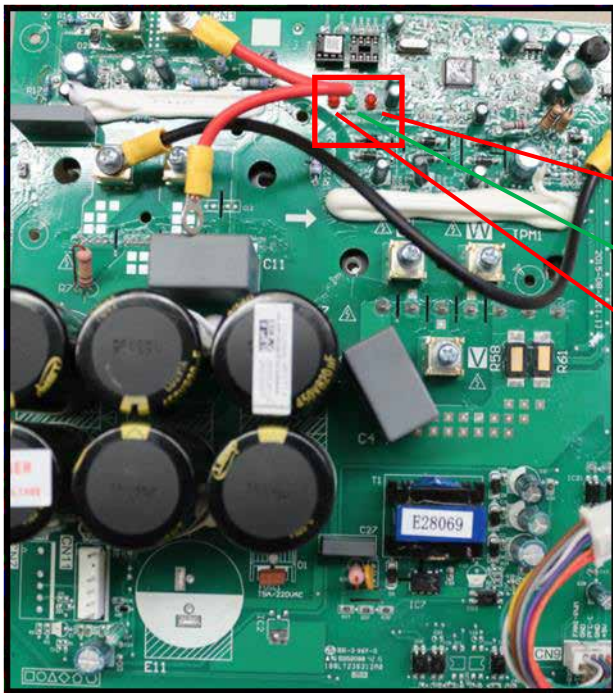

Pic 2: IPM (for 4 zone & 5 zone)

Operating

Standby

Power



PIC3: Main board LED when power on and unit standby.

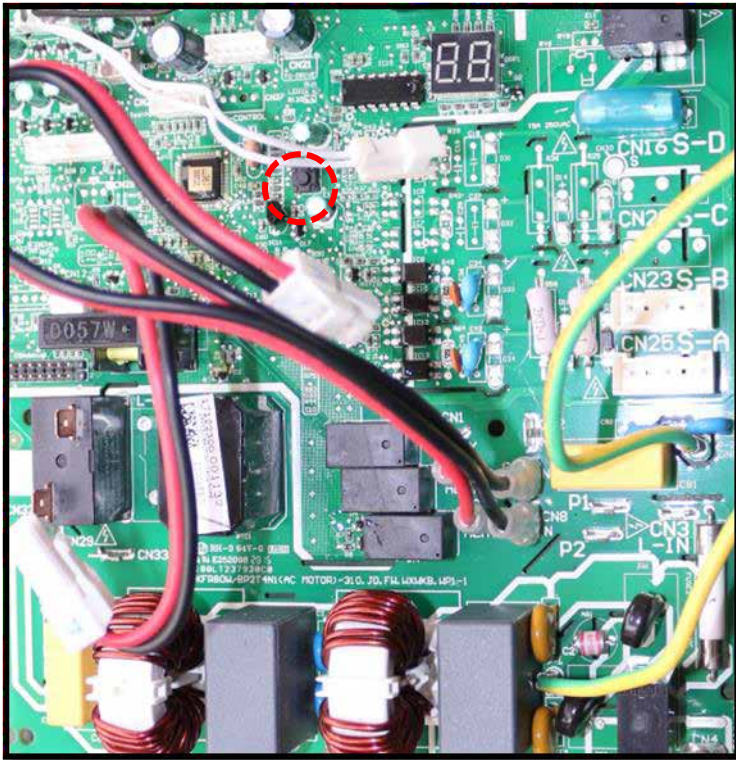

PIC 4: Check point button, press 1 time for check how many indoor units are connected.

**7.4.2.3 E3/ PC 40 (Communication malfunction between IPM board and outdoor main control board) diagnosis**

<b>Error Code</b>	<b>E3/ PC 40</b>
<b>Malfunction conditions</b>	PCB main chip does not receive feedback from IPM module during 60 seconds.
<b>Potential causes</b>	<ul style="list-style-type: none"> <li>● Wiring mistake</li> <li>● Faulty PCB</li> </ul>

**Trouble shooting:**

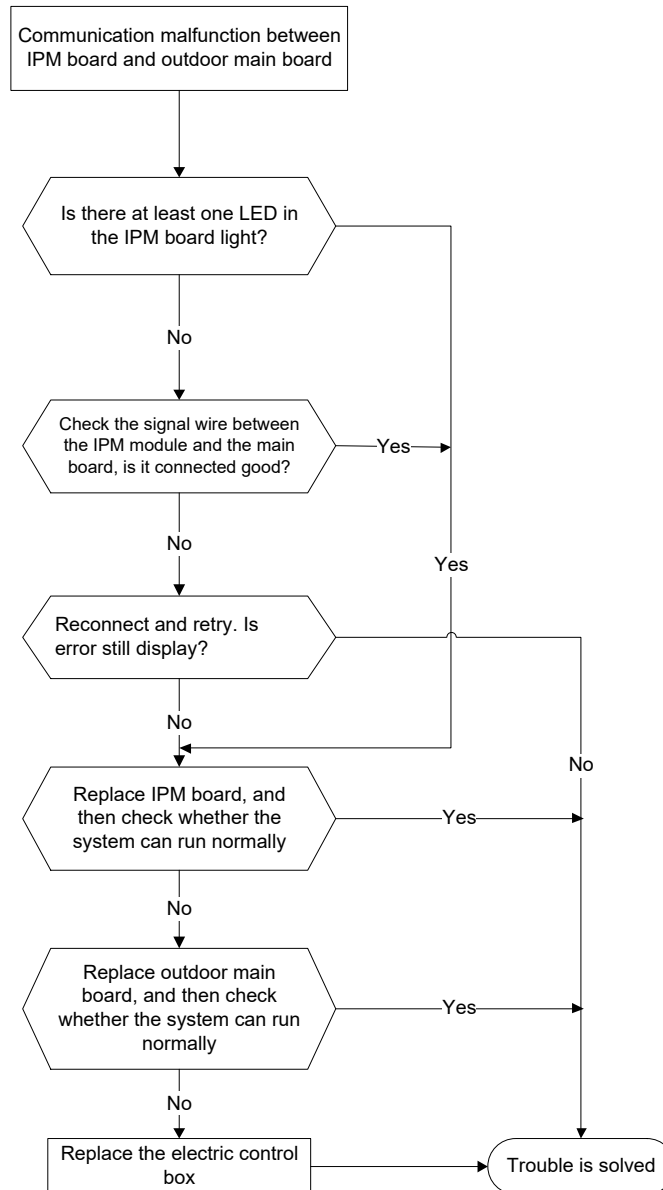



**Remark:**

Use a multimeter to test the DC voltage between black pin and white pin of signal wire. The normal value should be around 5V.

Use a multimeter to test the DC voltage between black pin and red pin of signal wire. The normal value should be around 12V.

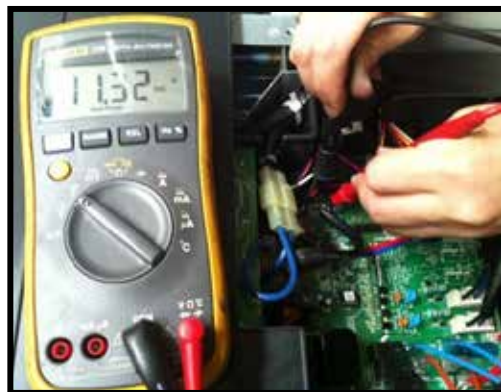
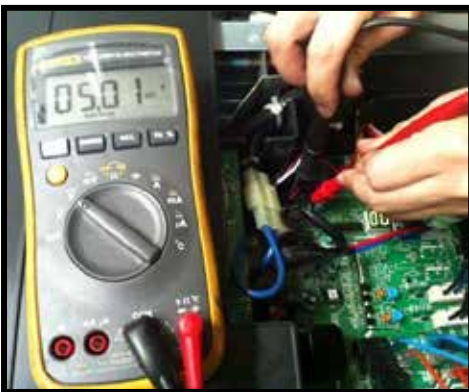

**7.4.2.4 E4/EC 50 (Outdoor temperature sensor (coil sensor T3, ambient sensor T4, Compressor discharge sensor T5、 indoor coil outlet pipe sensor T2B) malfunction) diagnosis and solution F1/F2/F3/F4/F5 (No.A,B,C,D,E Indoor unit coil outlet temp. sensor malfunction) diagnosis and solution.**

**Outdoor room temperature sensor T4 is in open circuit or has short circuited(EC 53)**

**Compressor discharge temperature sensor T5 is in open circuit or has short circuited(EC 54)**

**Evaporator coil outlet temperature sensor T2B is in open circuit or has short circuited(EC 56)**

Error Code	E4/F1/F2/F3/F4/F5/ EC 52/EC 53/EC 54/EC 56/EC 50
Malfunction conditions	If the sampling voltage is lower than 0.06V or higher than 4.94V, the LED will display the failure.
Potential causes	<ul style="list-style-type: none"> <li>● Wiring mistake</li> <li>● Faulty sensor</li> <li>● Faulty PCB</li> </ul>

**Trouble shooting:**

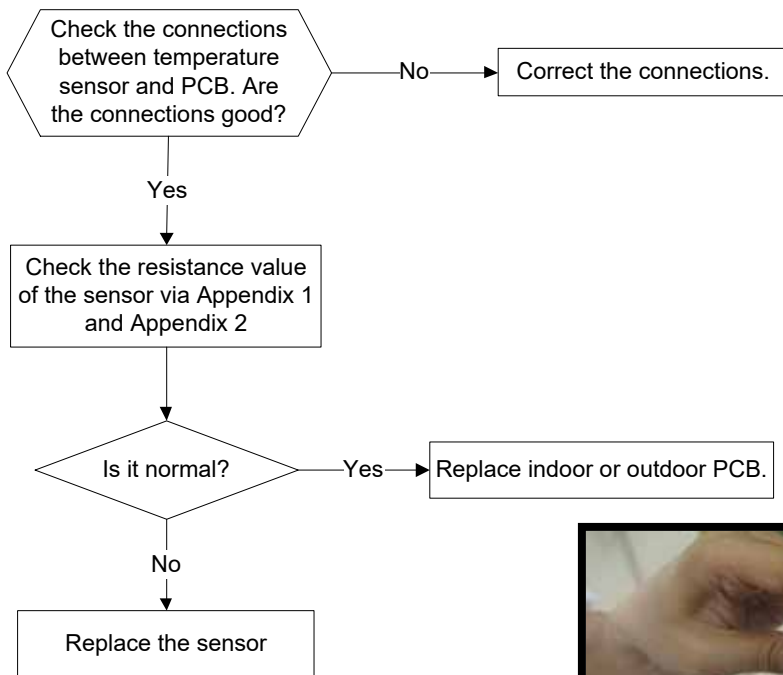

7.4.2.5 E5/ PC 10/PC 11/PC 12 (Over-voltage or under-voltage protection) diagnosis and solution.

Error Code	E5/ PC 10/PC 11/PC 12
<b>Malfunction conditions</b>	An abnormal voltage rise or drop is detected by checking the specified voltage detection circuit.
<b>Potential causes</b>	<ul style="list-style-type: none"> <li>● Power supply problems.</li> <li>● System leakage or block</li> <li>● Faulty PCB</li> </ul>

**Trouble shooting:**

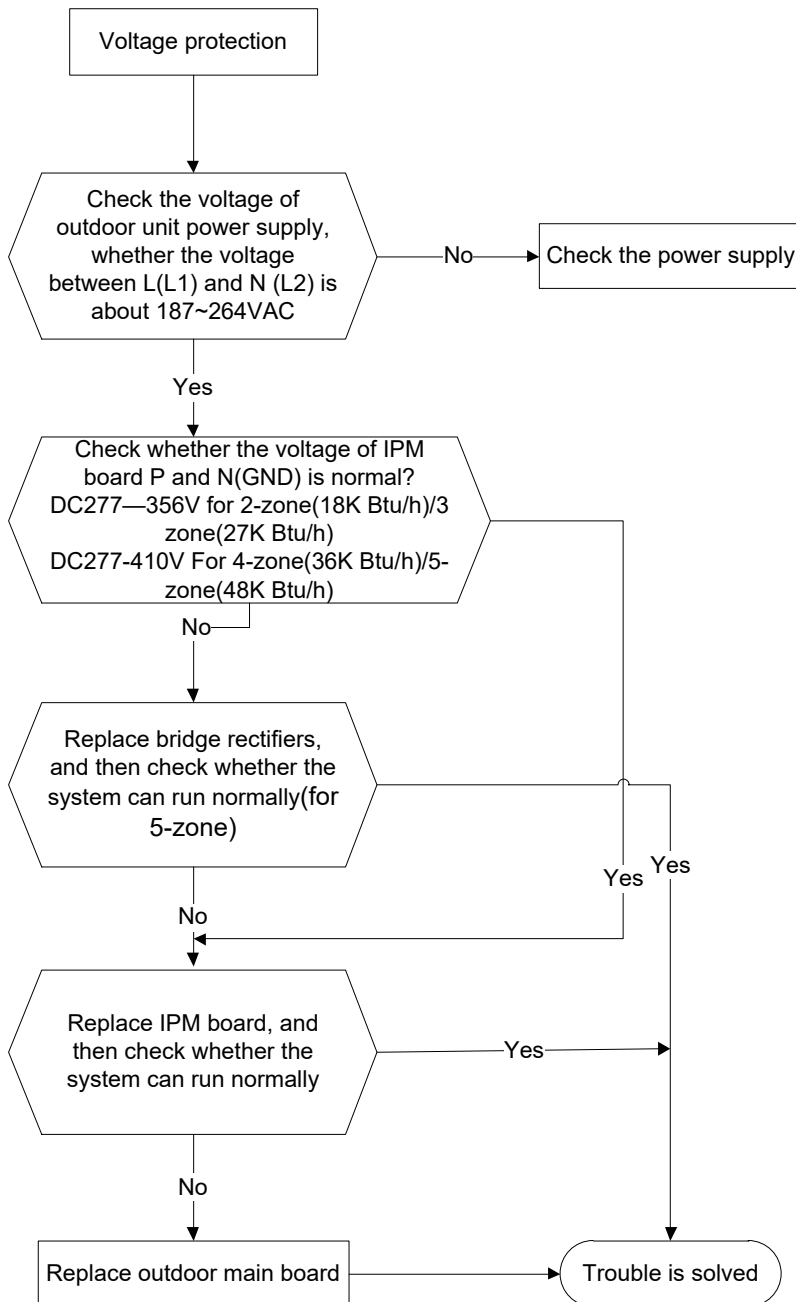

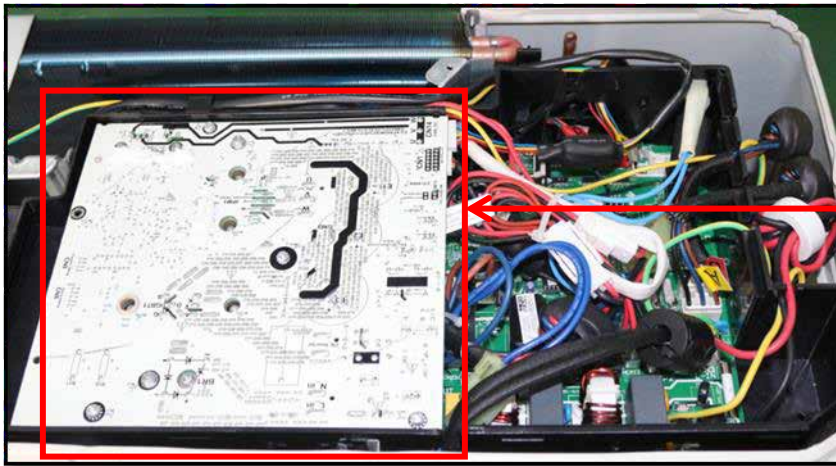

IPM board (for 2-zone /3-zone)

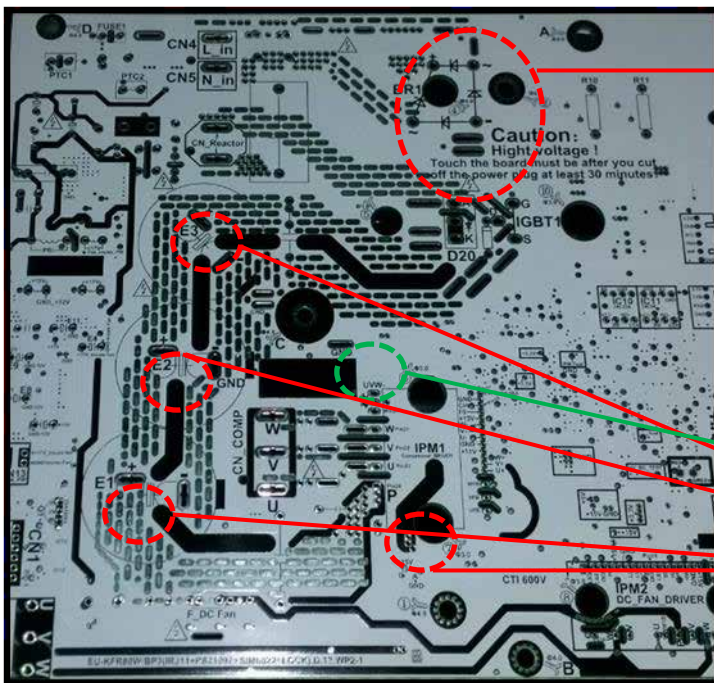

Bridge rectifier (for 2-zone/3-zone)

**Remark:**  
Measure the DC voltage between + and - port. The normal value should be 190V~250V.

P(or E1/E2/E3)-N(GND) (for 2-zone/3-zone)

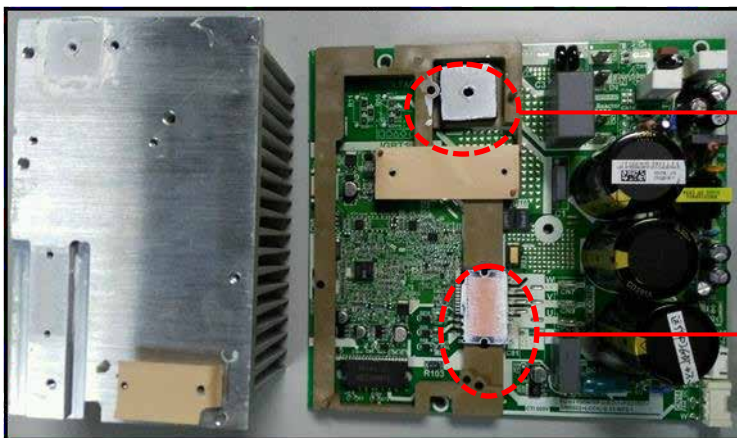

Bridge rectifier (for 2-zone/3-zone)

IPM Module (for 2-zone/3-zone)

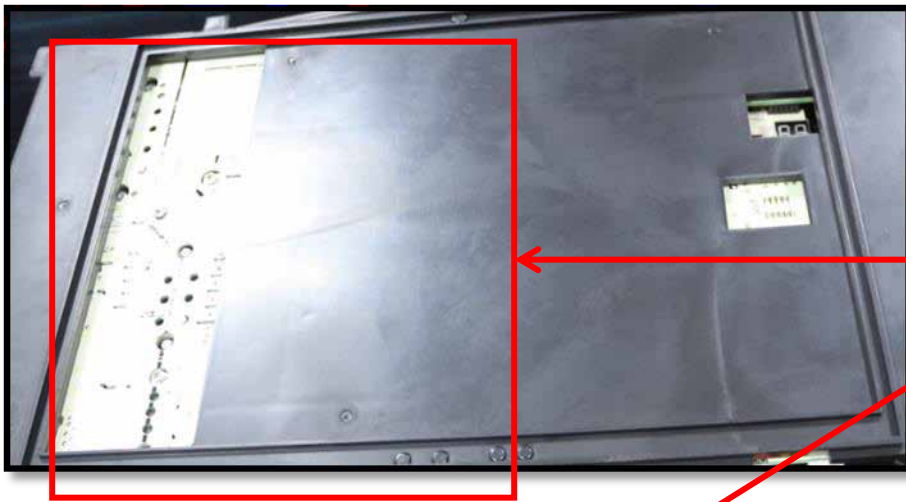

IPM board  
(for 4-zone)

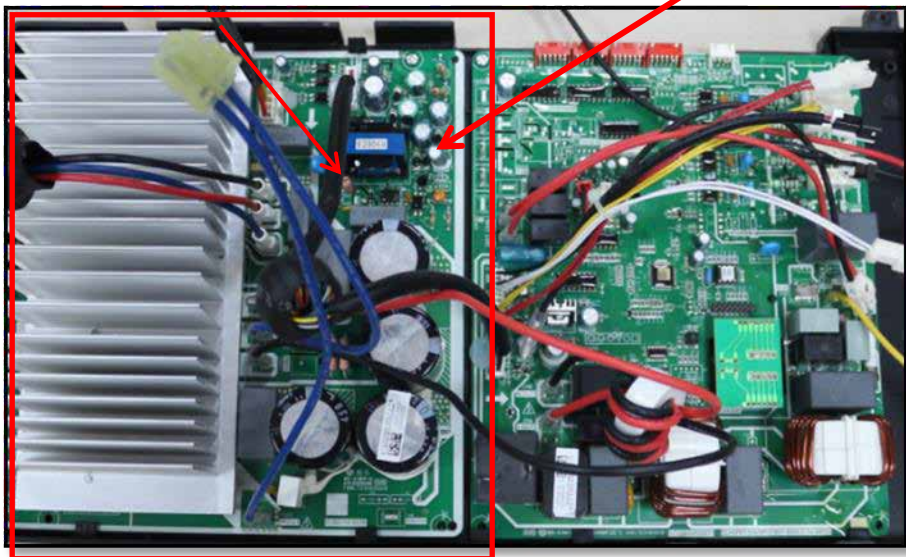

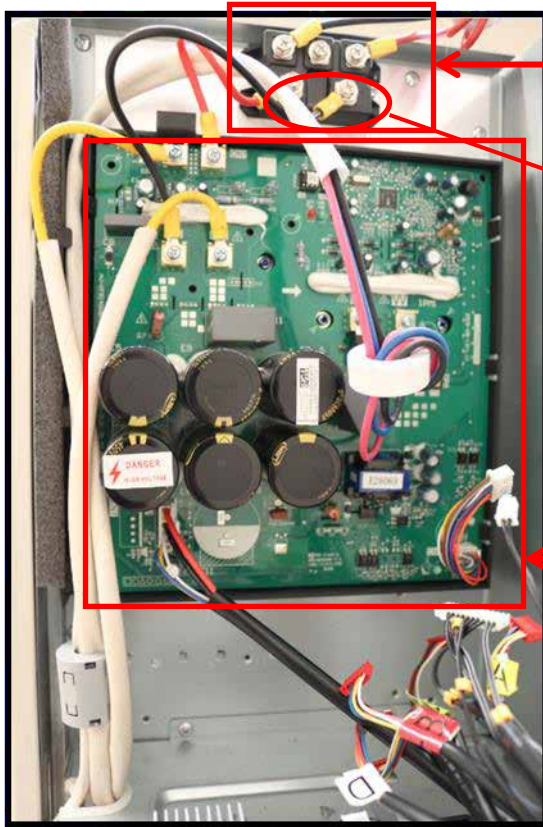

Bridge rectifier  
(for 5-zone)

**Remark:**  
Measure the DC voltage  
between + and - port. The  
normal value should be  
190V~250V.

IPM board  
(for 5-zone)

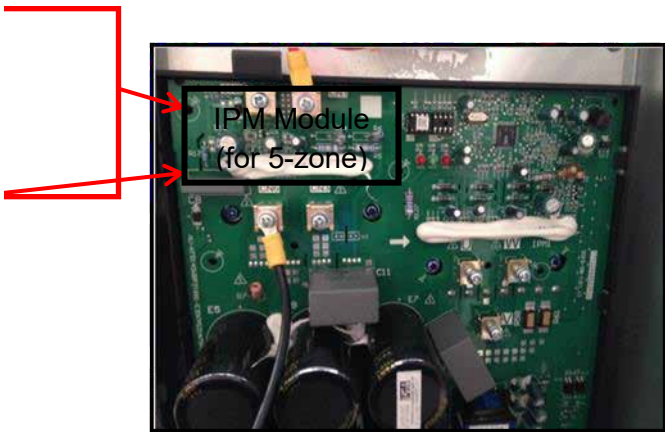

IPM Module  
(for 5-zone)



**7.4.2.6 E6/ PC 0F (PFC module protection) error diagnosis and solution.**

Error Code	E6/ PC 0F
<b>Malfunction conditions</b>	When the voltage signal that PFC sends to main control board is abnormal, the display LED will show “E6” and AC will turn off.
<b>Potential causes</b>	<ul style="list-style-type: none"> <li>● Wiring mistake</li> <li>● Faulty outdoor PCB</li> <li>● Faulty inductance of PFC module</li> <li>● PFC module malfunction</li> </ul>

**Trouble shooting:**

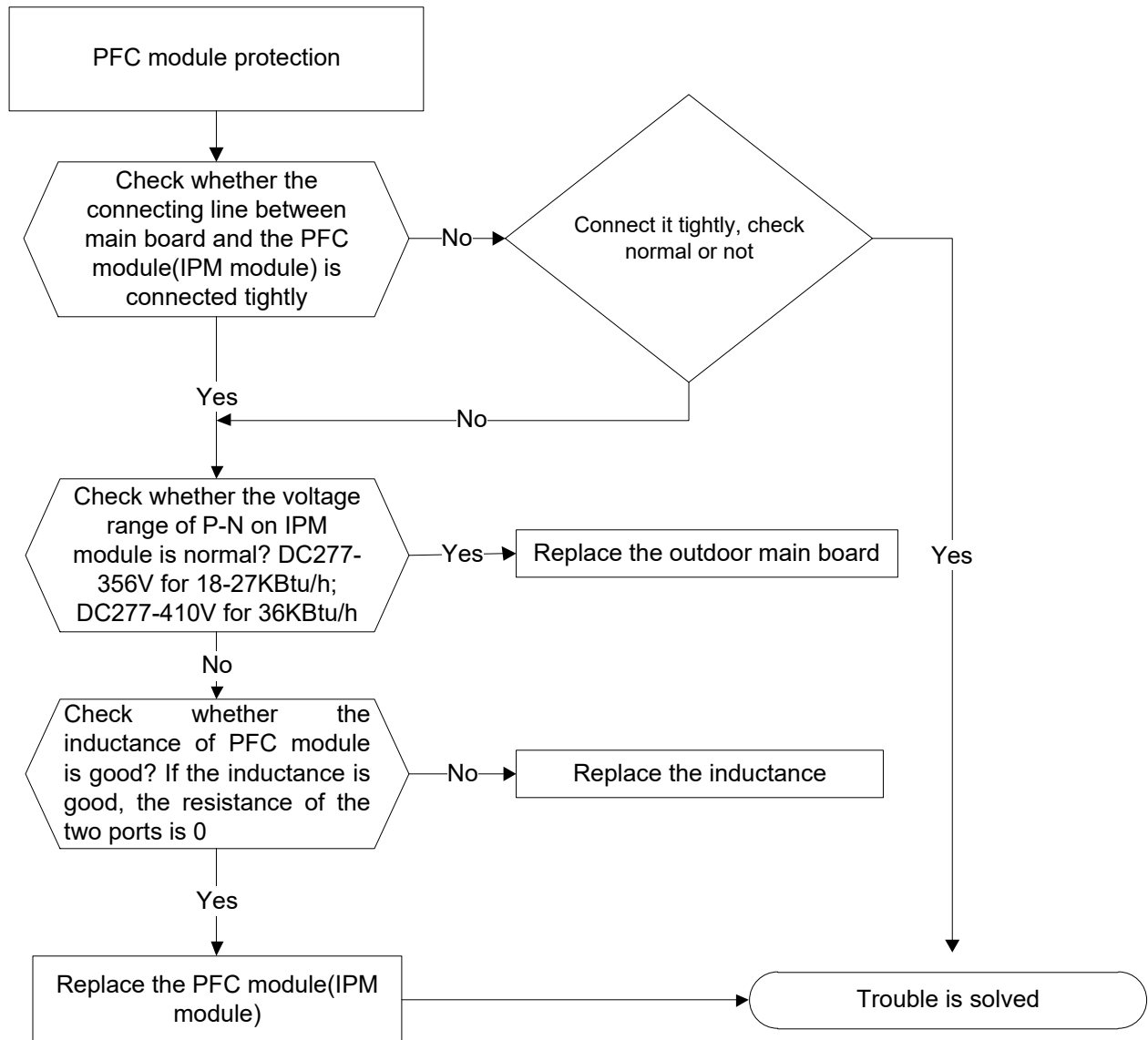

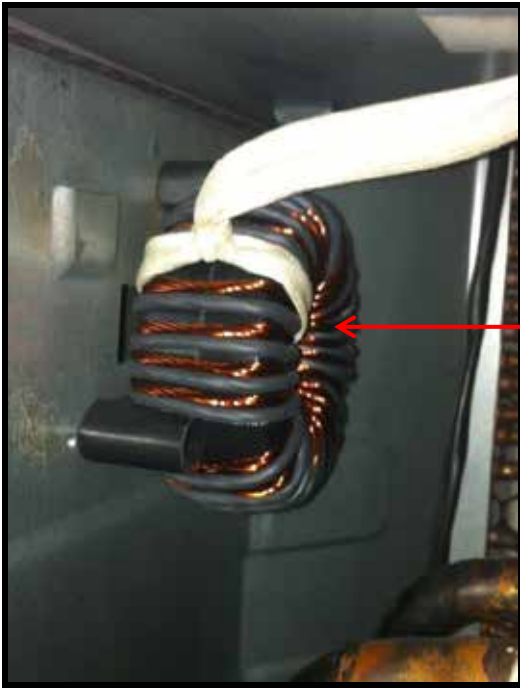

Inductance

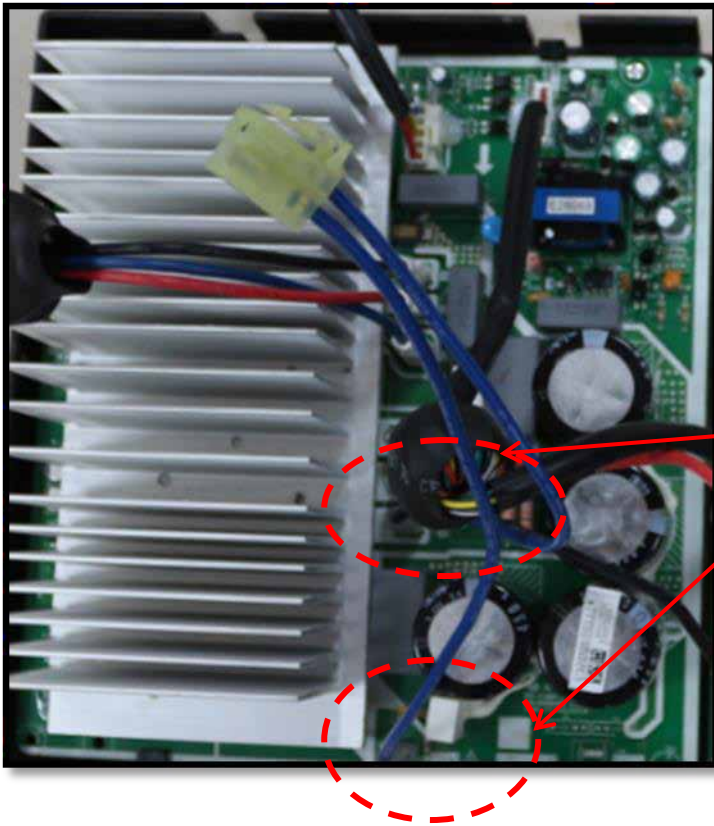

Two ports of the inductance

**7.4.2.7 E8/ EC 07 (Outdoor fan speed malfunction)/ EC 71(Over current failure of outdoor DC fan motor) diagnosis and solution**

Error Code	E8/ EC 07/ EC 71
<b>Malfunction conditions</b>	When outdoor fan speed keeps too low (300RPM) or too high(2400RPM) for certain time, the unit will stop and the LED will display the failure.
<b>Potential causes</b>	<ul style="list-style-type: none"> <li>● Wiring mistake</li> <li>● Faulty Fan assembly</li> <li>● Faulty Fan motor</li> <li>● Faulty PCB</li> </ul>

**Trouble shooting:**

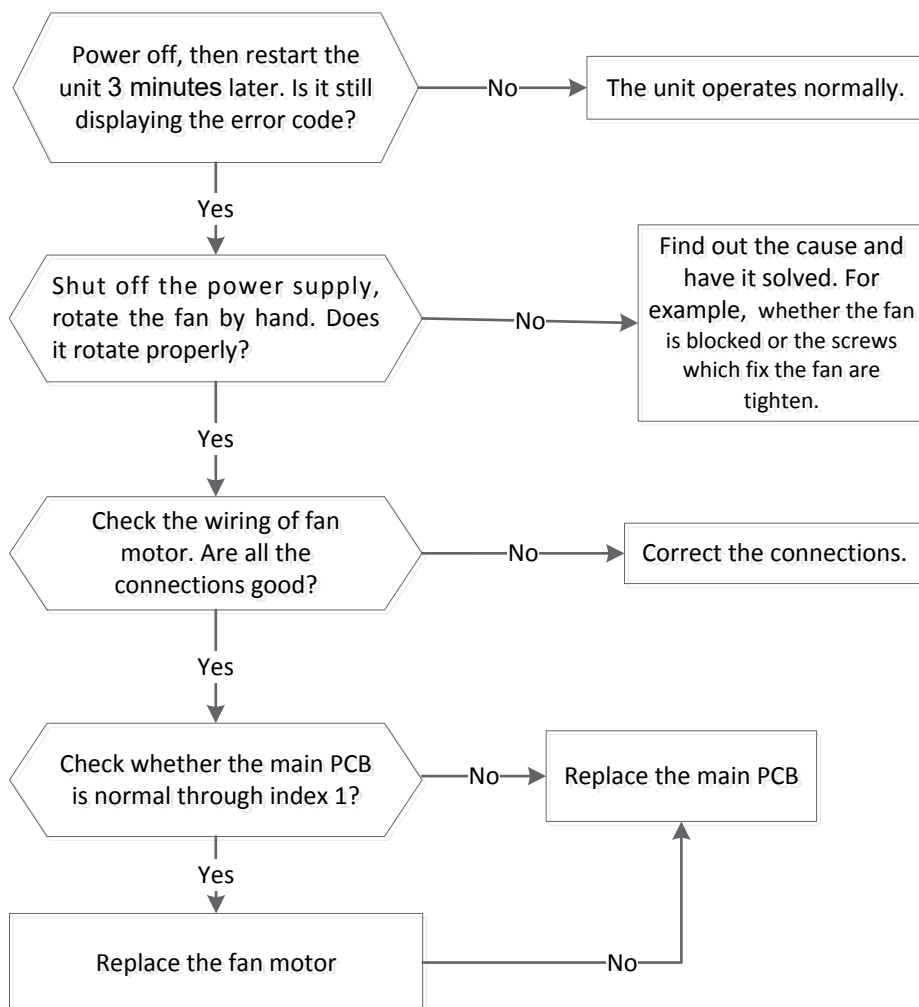

Index 1:

➤ **1. DC fan motor(control chip is inside fan motor)**

Power on and when the unit is in standby, measure the voltage of pin1-pin3, pin4-pin3 in fan motor connector. If the value of the voltage is not in the range showing in below table, the PCB must have problems and need to be replaced.

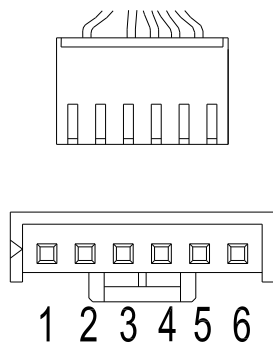

DC motor voltage input and output

NO.	Color	Signal	Voltage
1	Red	Vs/Vm	200~380V
2	---	---	---
3	Black	GND	0V
4	White	Vcc	13.5~16.5V
5	Yellow	Vsp	0~6.5V
6	Blue	FG	13.5~16.5V

Vs



Vcc



Vsp



FG

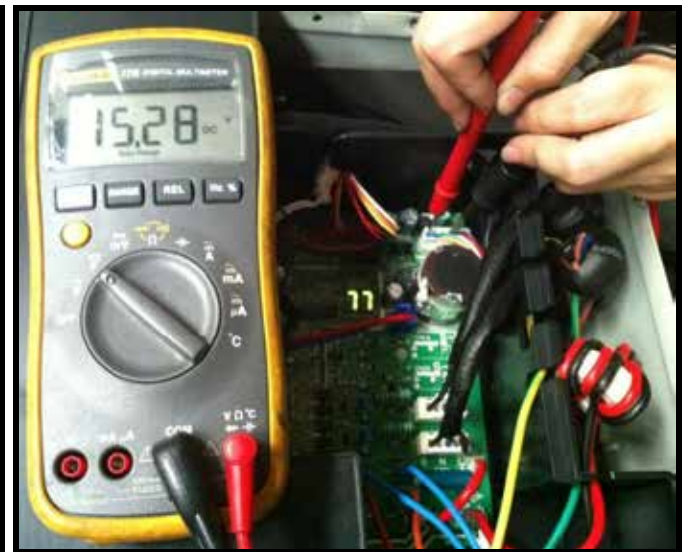

➤ **2. DC Fan Motor (control chip is in PCB)**

Release the UVW connector. Measure the resistance of U-V, U-W, and V-W. If the resistances are not equal to each other, the fan motor may be experiencing problems and need to be replaced. Otherwise, the PCB must have problems and need to be replaced.

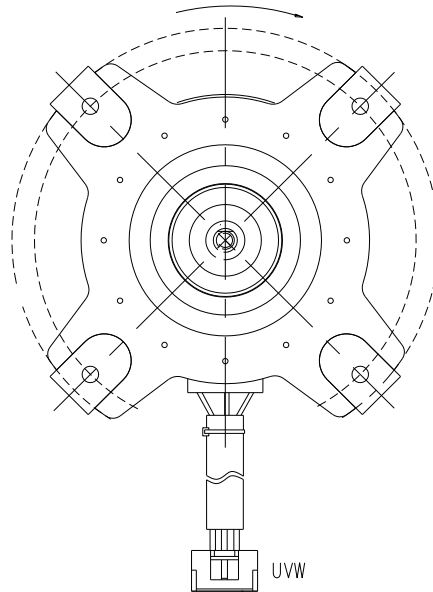

**7.4.2.8 P1/PC 30 (High pressure protection) diagnosis and solution.**

Error Code	P1/PC 30
<b>Malfunction conditions</b>	If the sampling voltage is not 5V, the LED will display the failure.
<b>Potential causes</b>	<ul style="list-style-type: none"> <li>● Wiring mistake</li> <li>● Faulty over load protector</li> <li>● System block</li> <li>● Faulty outdoor PCB</li> </ul>

**Trouble shooting:**

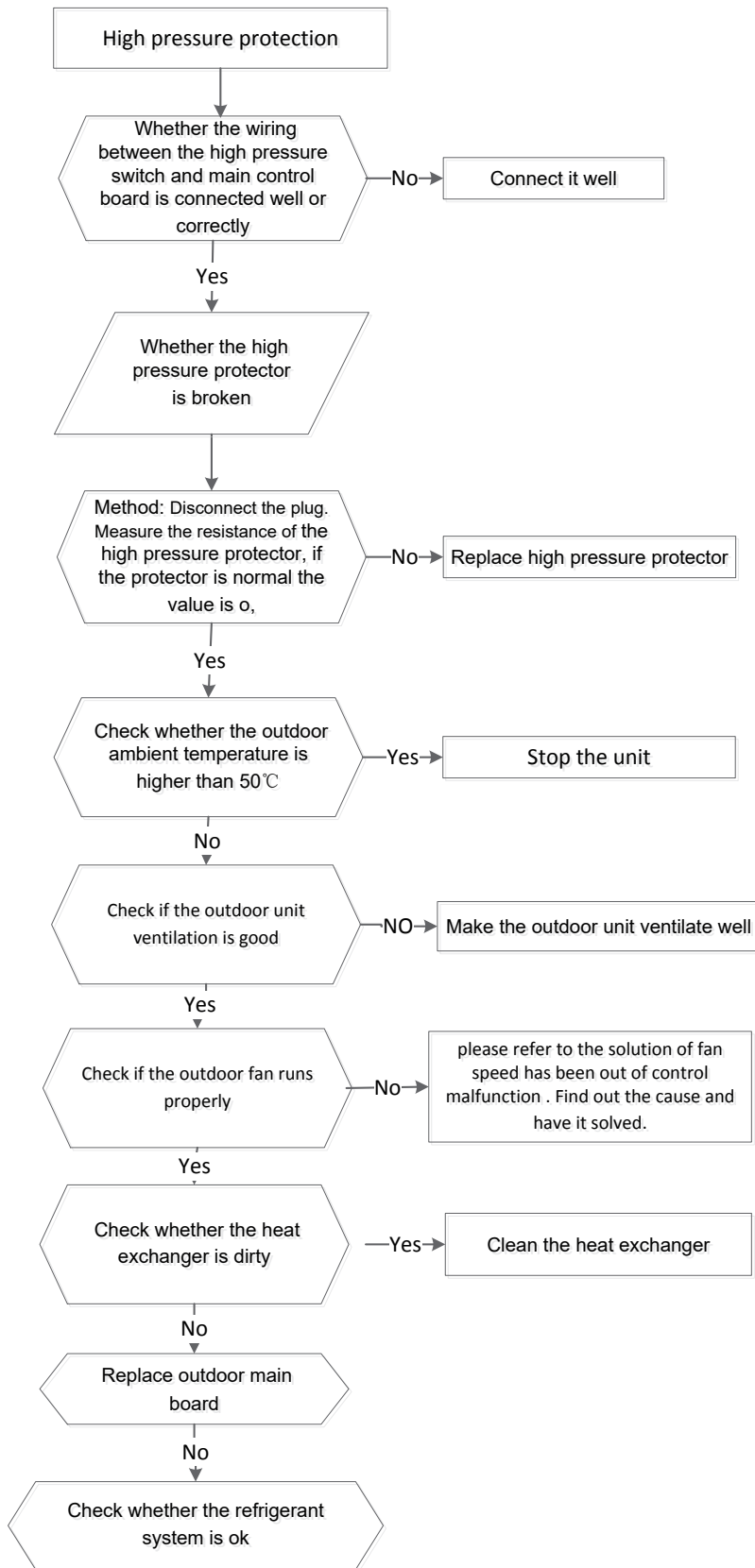

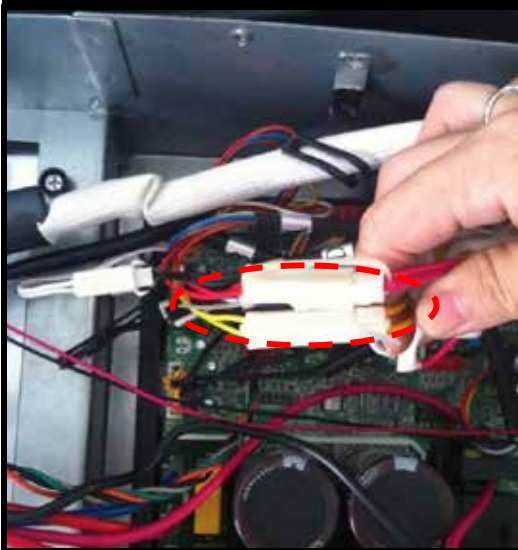
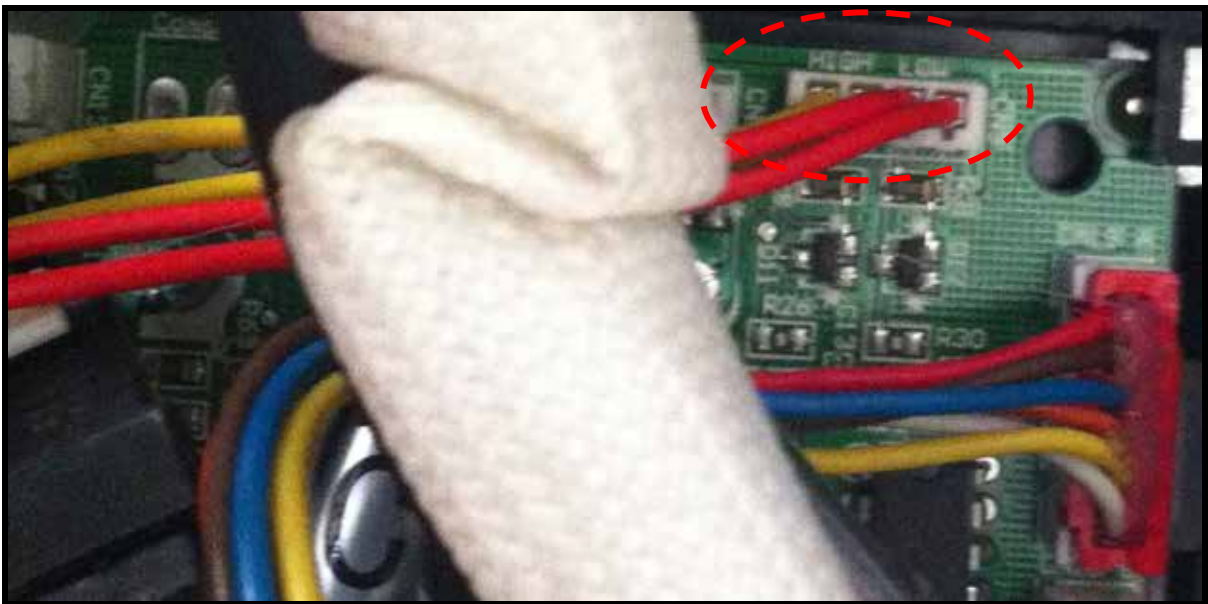

#### 7.4.2.9 P2/PC 31 (Low pressure protection) diagnosis and solution.

Error Code	P2/PC 31
Malfunction conditions	If the sampling voltage is not 5V, the LED will display the failure.
Potential causes	<ul style="list-style-type: none"> <li>● Wiring mistake</li> <li>● Faulty over load protector</li> <li>● System block</li> <li>● Faulty outdoor PCB</li> </ul>

**Trouble shooting:**

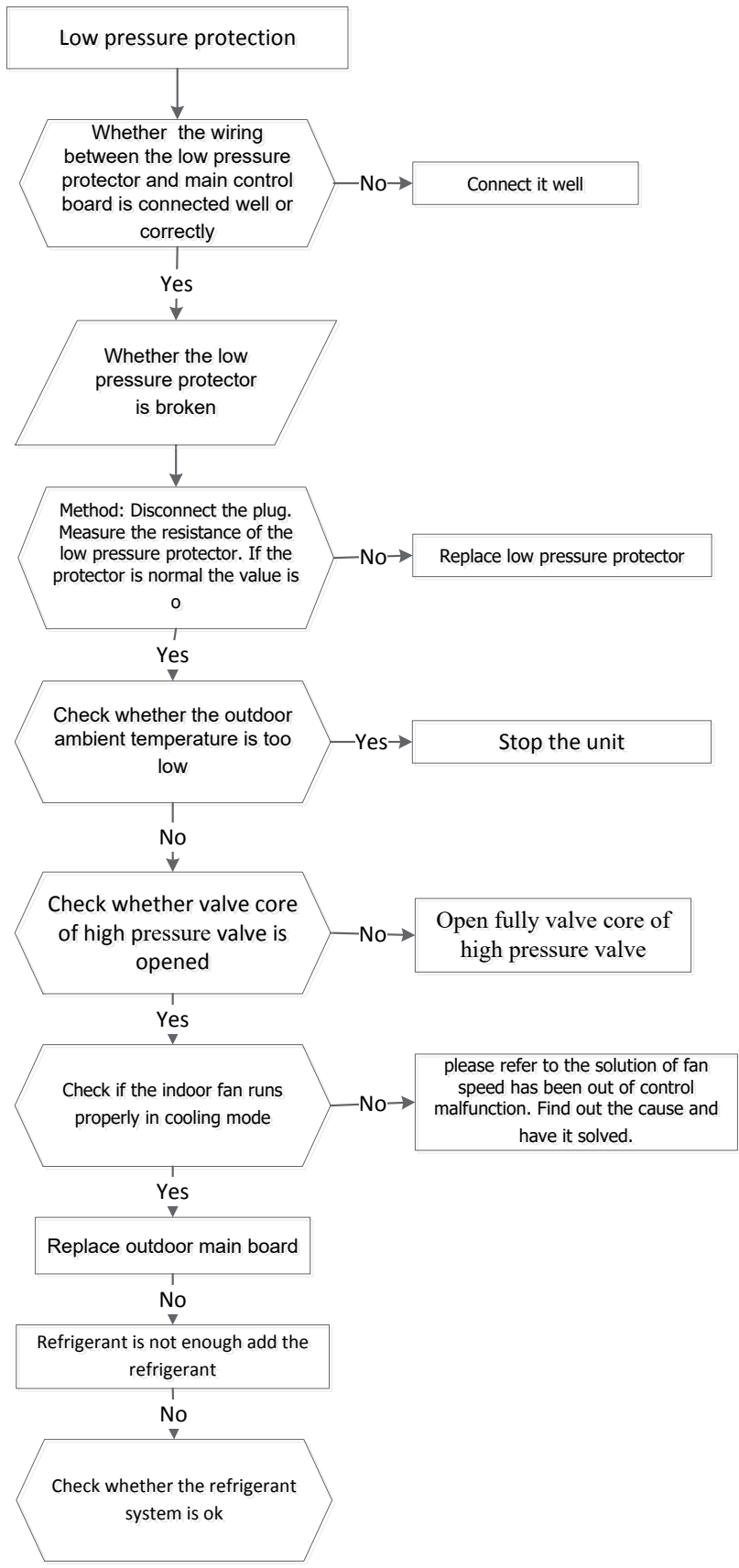

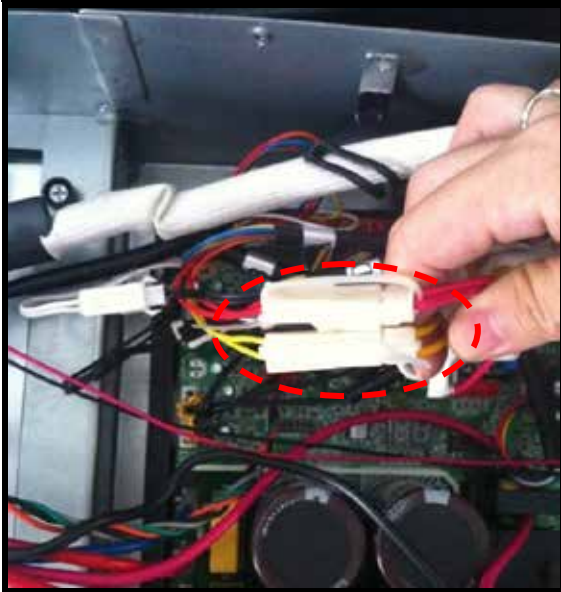
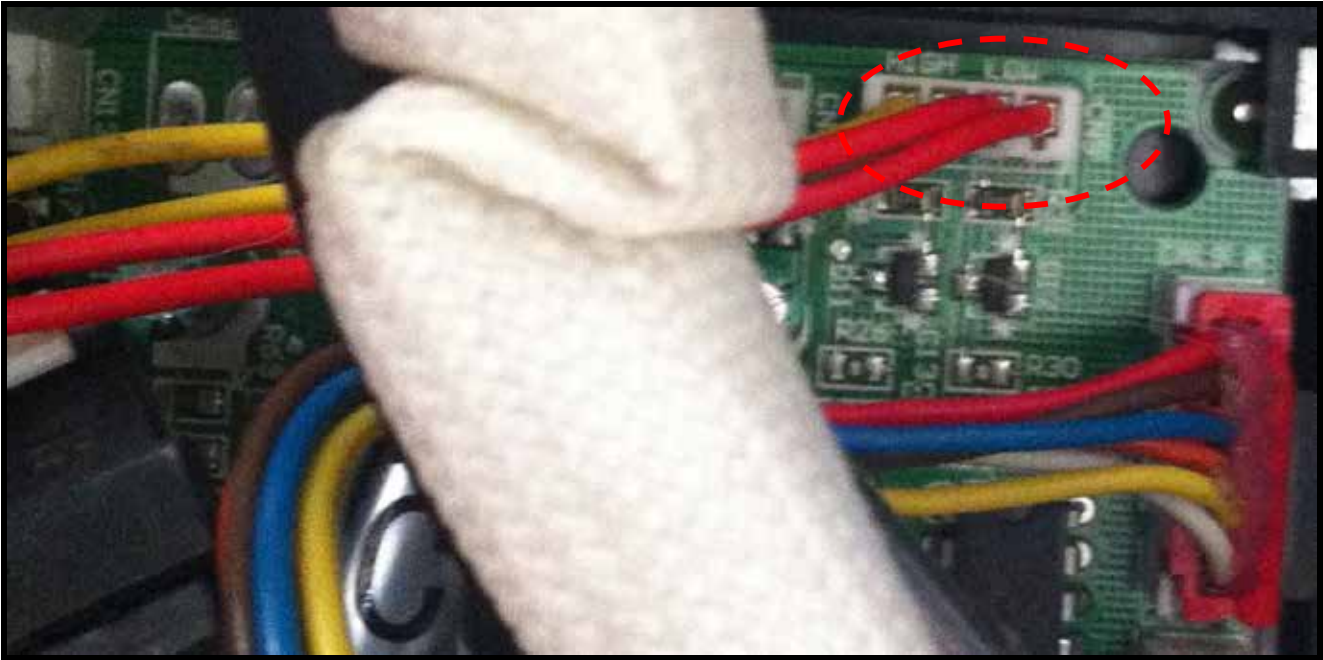

**7.4.2.10 P3/PC 08 (Current overload protection)/ PC 44(Outdoor unit zero speed protection)/PC 46(Compressor speed has been out of control)/PC 49(Compressor overcurrent failure) diagnosis and solution.**

<b>Error Code</b>	<b>P3/PC 08/PC 44/PC 46/PC 49</b>
<b>Malfunction conditions</b>	If the outdoor current exceeds the current limit value, the LED will display the failure.
<b>Potential causes</b>	<ul style="list-style-type: none"> <li>● Wiring mistake</li> <li>● Faulty over load protector</li> <li>● System block</li> <li>● Faulty outdoor PCB</li> </ul>

**Trouble shooting:**

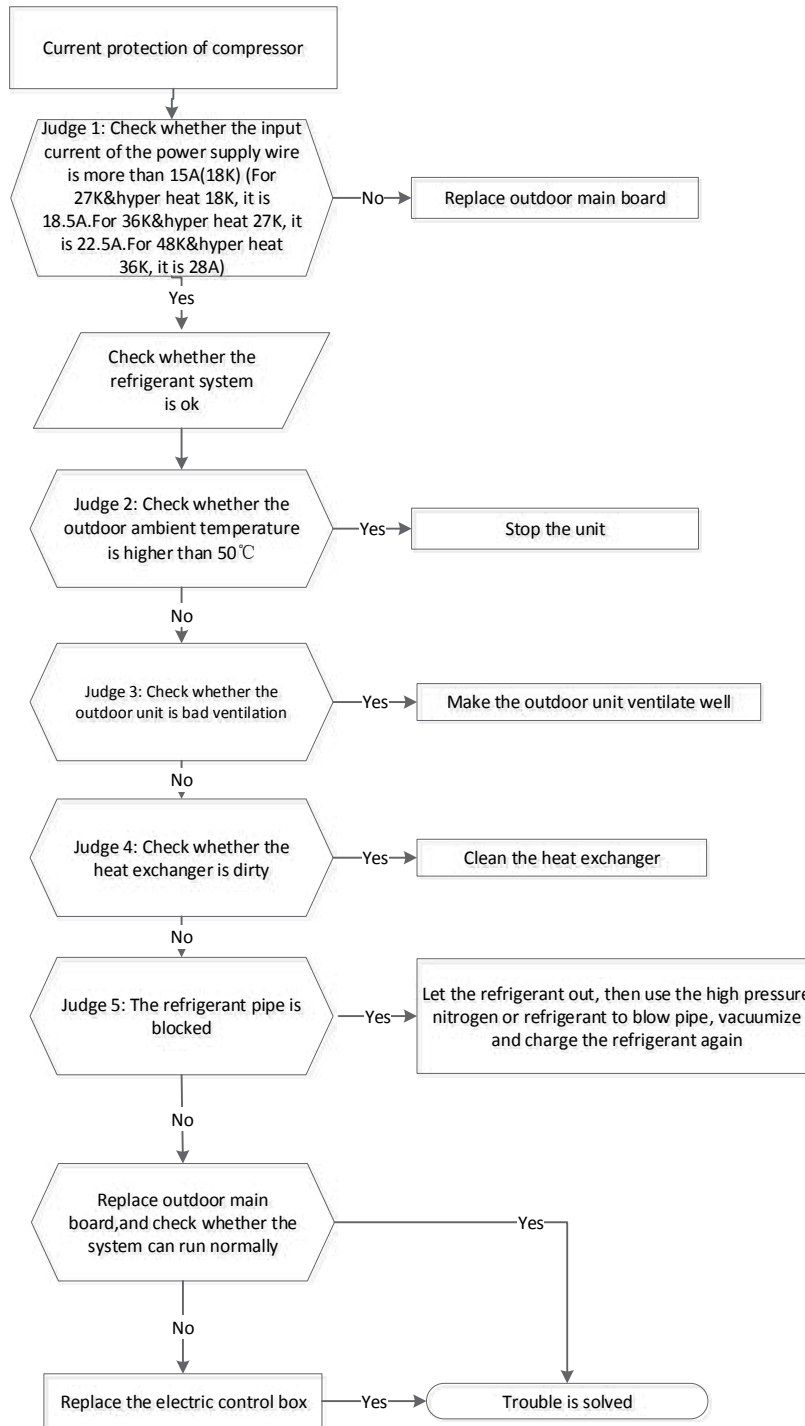



**7.4.2.11 P4/PC 06 (Temperature protection of compressor discharge) diagnosis and solution.**

Error Code	P4/PC 06
<b>Malfunction conditions</b>	When the compressor discharge temperature(T5) is more than 115°C for 10 seconds, the compressor will stop and restart till T5 is less than 90°C.
<b>Potential causes</b>	<ul style="list-style-type: none"> <li>● Refrigerant leakage</li> <li>● Wiring mistake</li> <li>● Faulty discharge temperature sensor</li> <li>● Faulty outdoor PCB</li> </ul>

**Trouble shooting:**

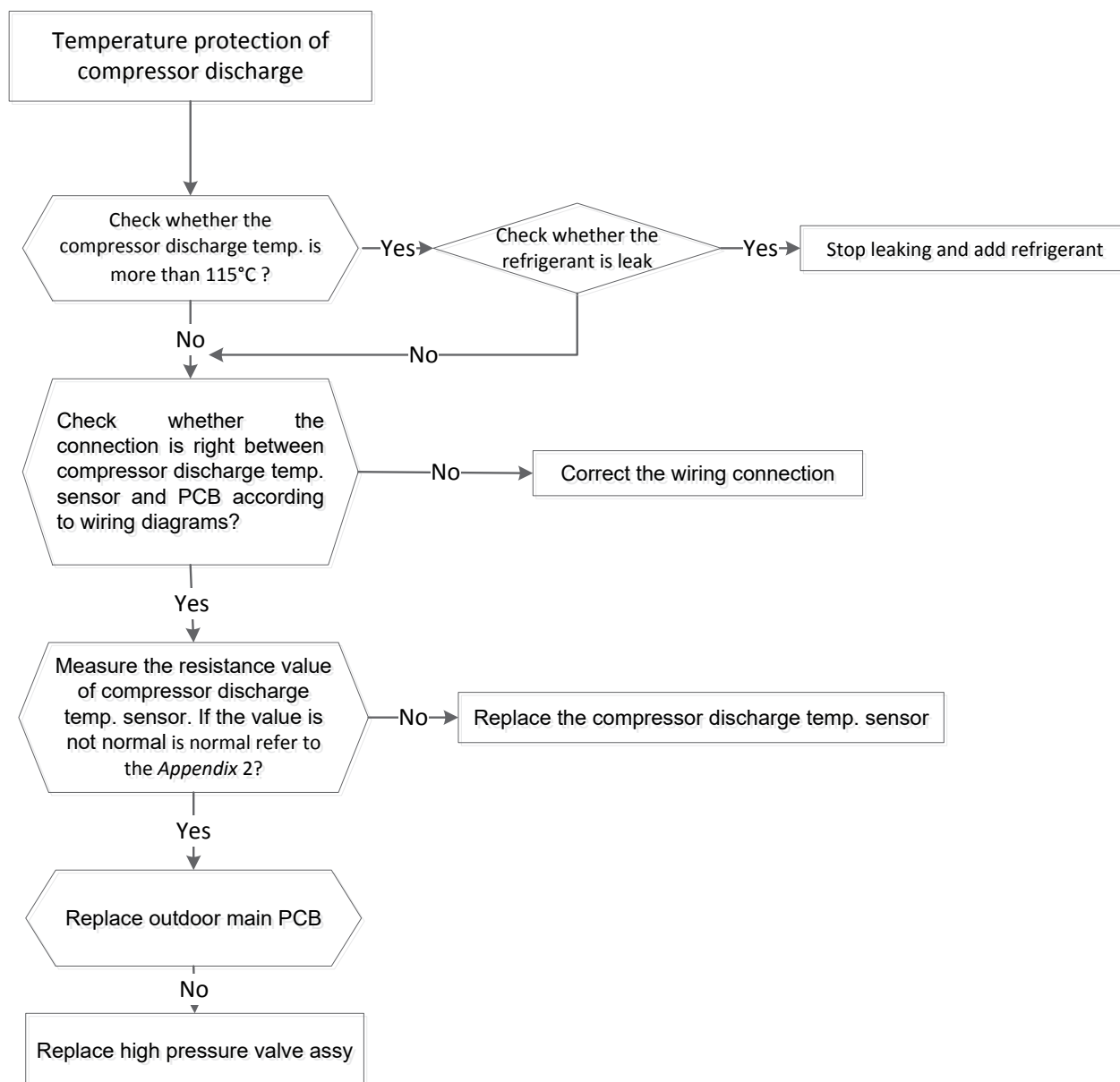

**7.4.2.12 P5/PC 0A (High temperature protection of condenser) diagnosis and solution.**

Error Code	P5/PC 0A
<b>Malfunction conditions</b>	When outdoor pipe temperature is more than 65°C, the unit will stop, and unit runs again when outdoor pipe temperature is less than 52°C
<b>Potential causes</b>	<ul style="list-style-type: none"> <li>● Faulty condenser temperature sensor</li> <li>● Heat exchanger dirty</li> <li>● System block</li> </ul>

**Trouble shooting:**

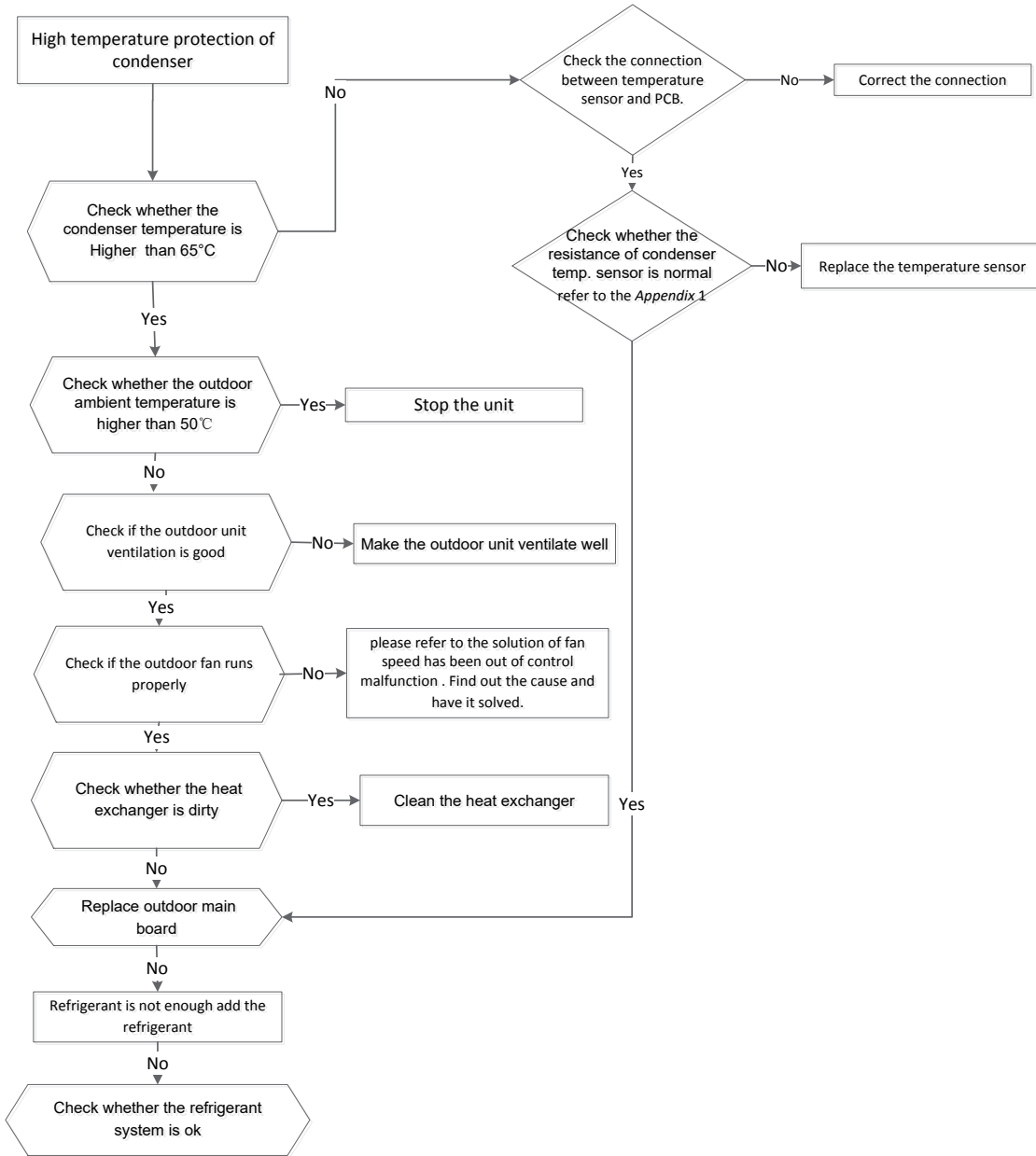

**7.4.2.13 P6/PC 00 (Inverter module (IPM) malfunction) diagnosis and solution.**

Error Code	P6/PC 00
<b>Malfunction conditions</b>	When the voltage signal that IPM send to compressor drive chip is abnormal, the display LED will show “P6” and AC will turn off.
<b>Potential causes</b>	<ul style="list-style-type: none"> <li>● Wiring mistake</li> <li>● IPM malfunction</li> <li>● Faulty outdoor fan assembly</li> <li>● Compressor malfunction</li> </ul>

- Faulty outdoor PCB

**Trouble shooting:**

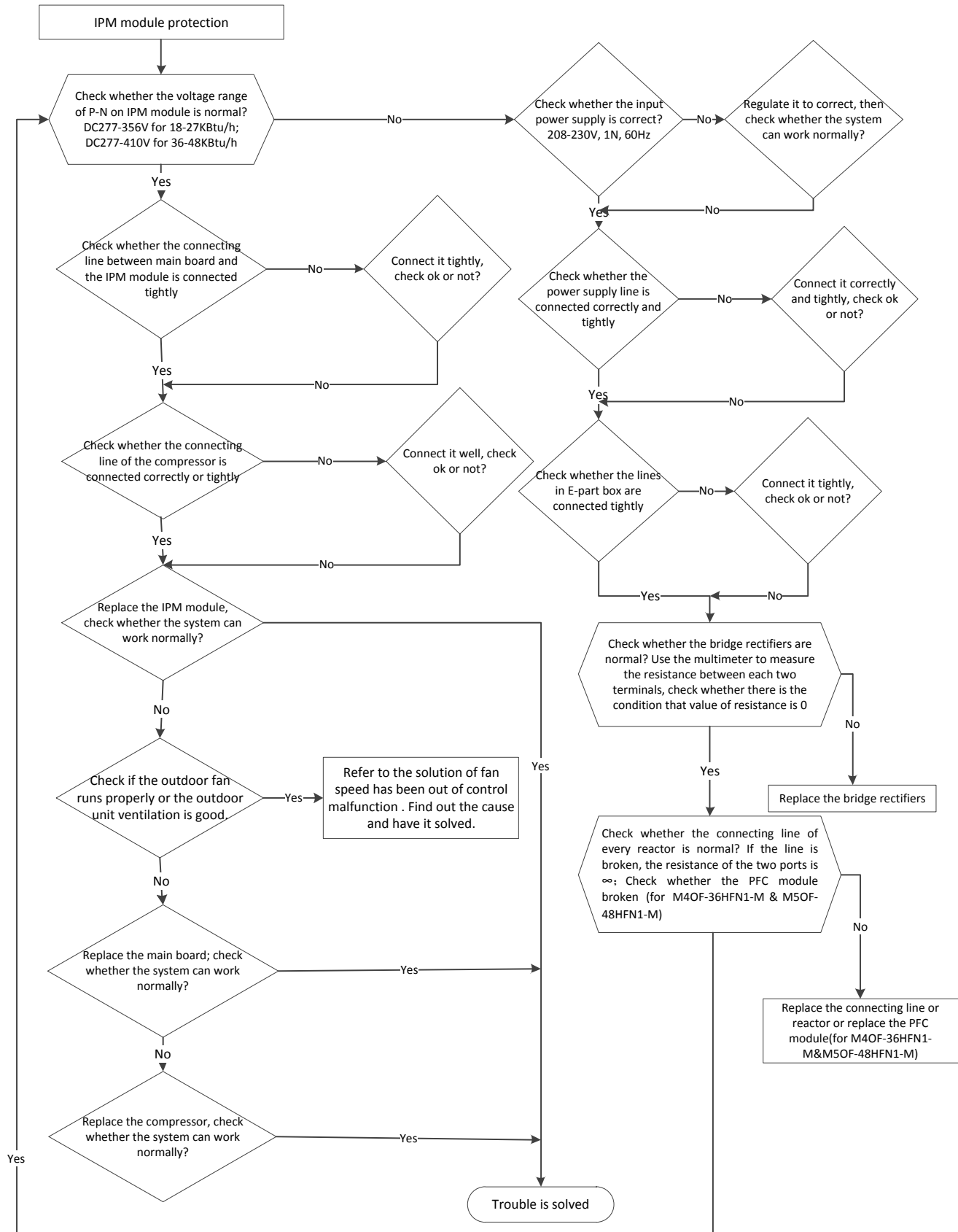

7.4.2.14. High temperature protection of compressor top(IDU P2/ODU P0/PC 02)

<b>Malfunction decision conditions</b>	<b>If the sampling voltage is not 5V, the LED will display the failure.</b>
<b>Supposed causes</b>	<ul style="list-style-type: none"> <li>● Faulty overload protector</li> <li>● Wiring mistake</li> <li>● System leakage or block</li> <li>● Faulty PCB</li> </ul>

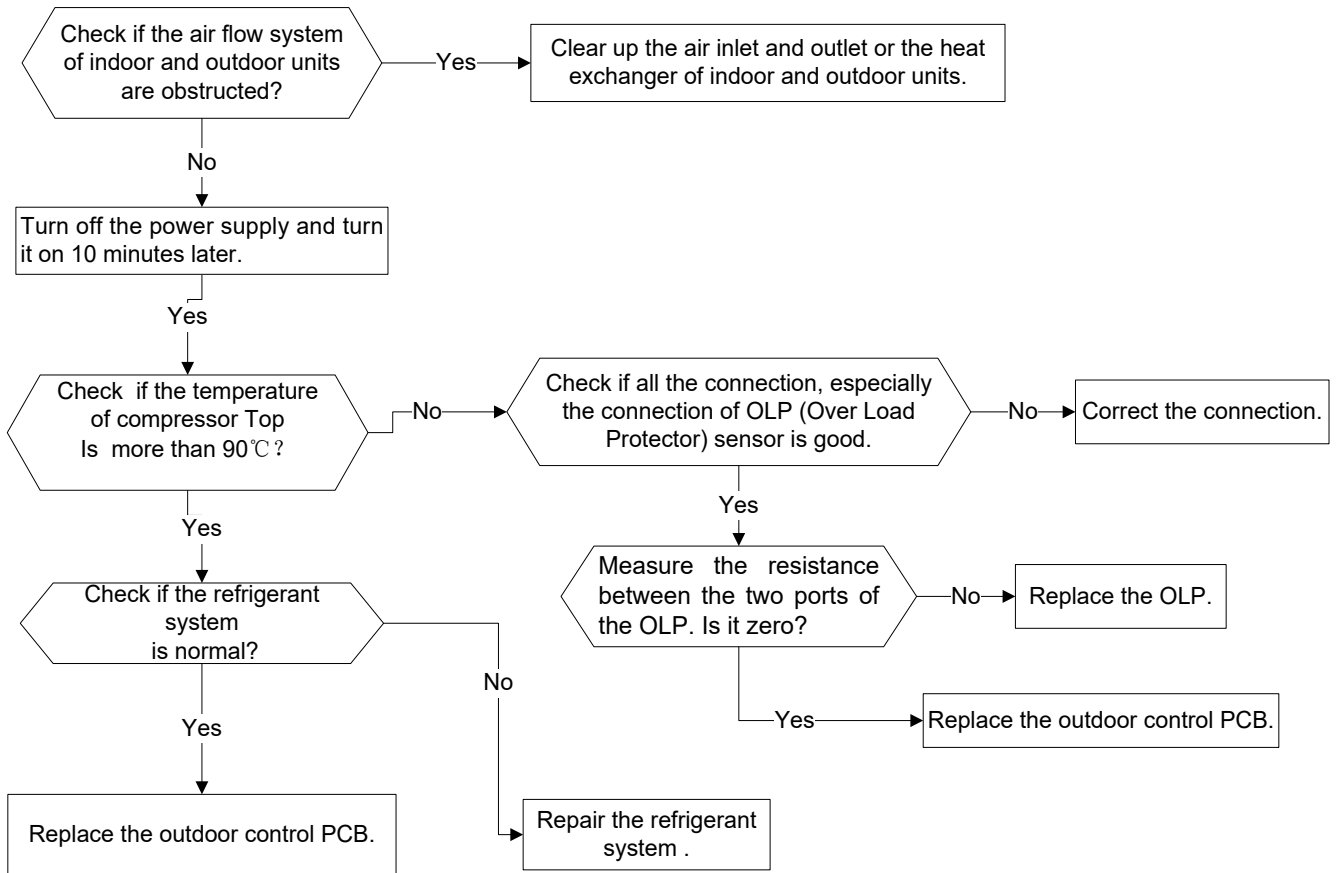

### 7.4.2.15 Lack phase failure of outdoor DC fan motor(EC 72)

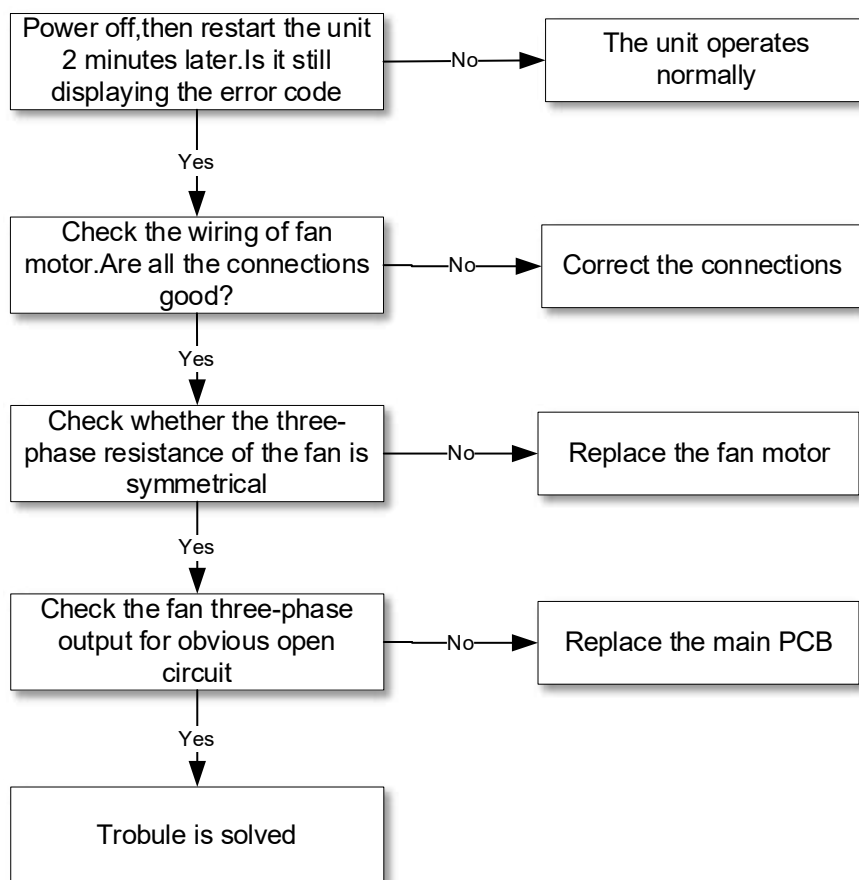

### 7.4.2.16 Outdoor compressor lack phase protection(PC43)

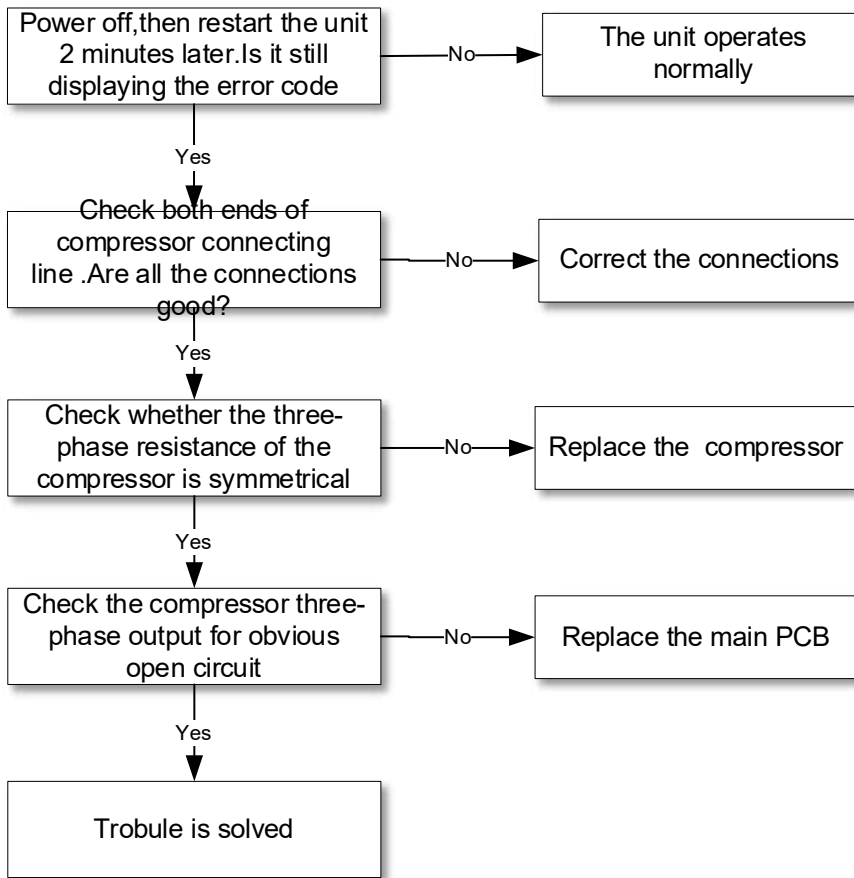

### 7.4.2.17 Outdoor unit IR chip drive failure(PC45)

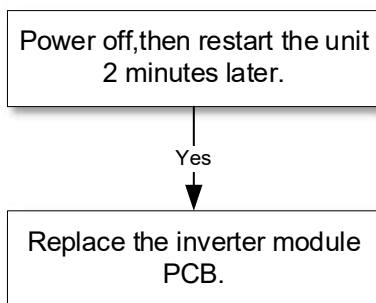

#### 7.4.2.18 The cooling operation or heating operation does not operate.

##### Potential causes

- Faulty 4-way valve

Check of 4-way, please refer to part 5 in 9.5 Trouble Criterion Of Main Parts.

#### 7.4.2.19 When cooling, heat exchanger of non-operating indoor unit frosts. When heating, non-operating indoor unit get warm.

##### Potential causes

- Faulty EXV
- Wire and piping connected in reverse.

Check of EXV, please refer to part 6 in 9.5 Trouble Criterion Of Main Parts.

#### 7.4.2.20 Automatic correction of wiring/piping error:

Press the "check switch" on the outdoor unit PCB board 5 seconds until LED display "CE", which mean this function is working, Approximately 5-10 minutes after the switch is pressed, the "CE" disappear the wiring/piping error will be corrected, and wiring/piping is properly connected.

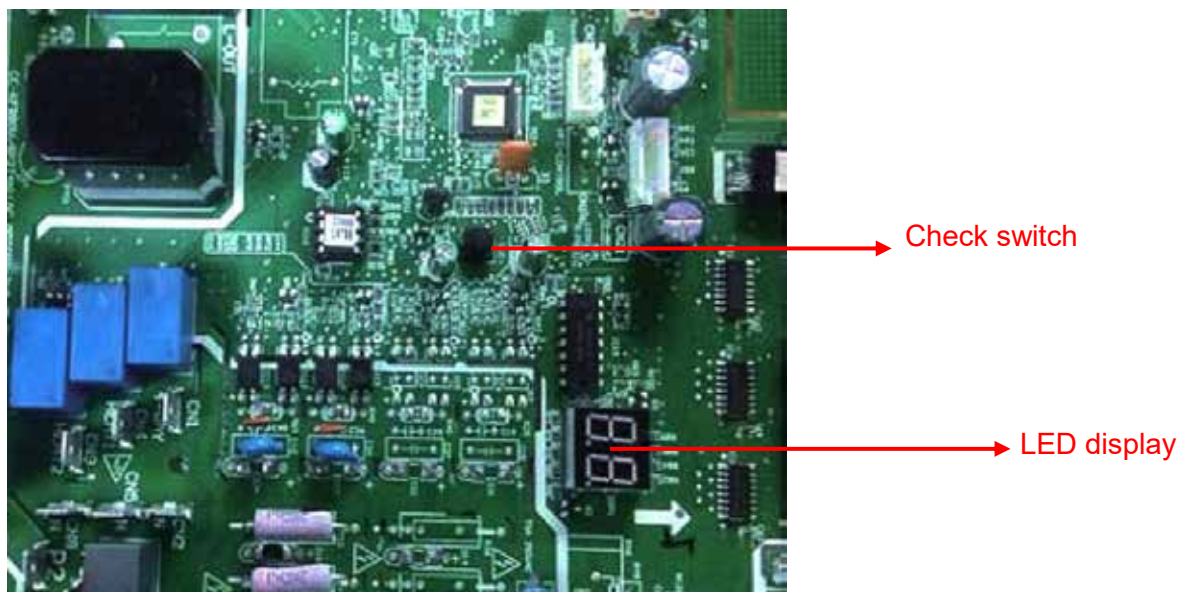

7.4.2.17 Communication malfunction between adapter board and outdoor main control board(ODU Ed)

<b>Malfunction decision conditions</b>	<b>If outdoor PCB does not receive feedback from adapter board.</b>
<b>Supposed causes</b>	<ul style="list-style-type: none"> <li>● Wiring mistake</li> <li>● Faulty PCB</li> </ul>

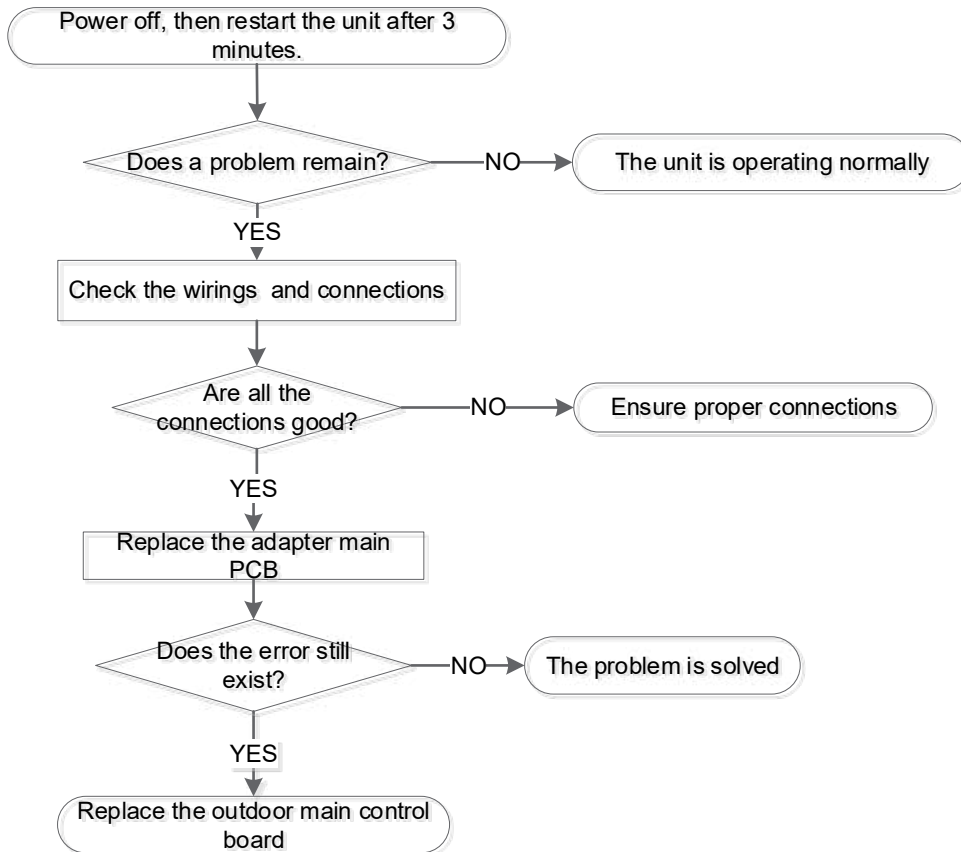

## 7.5 Trouble Criterion of Main Parts.

### 1. Temperature sensor checking

Disconnect the temperature sensor from PCB, measure the resistance value with a tester.



Temperature Sensors.

Room temp.(T1) sensor,

Indoor coil temp.(T2) sensor,

Outdoor coil temp.(T3) sensor,

Outdoor ambient temp.(T4) sensor,

Compressor discharge temp.(T5) sensor.

Measure the resistance value of each winding by using the multi-meter.

**Appendix 1 Temperature Sensor Resistance Value Table (°C--K)**

°C	K Ohm	°C	K Ohm	°C	K Ohm	°C	K Ohm
-20	115.266	20	12.6431	60	2.35774	100	0.62973
-19	108.146	21	12.0561	61	2.27249	101	0.61148
-18	101.517	22	11.5000	62	2.19073	102	0.59386
-17	96.3423	23	10.9731	63	2.11241	103	0.57683
-16	89.5865	24	10.4736	64	2.03732	104	0.56038
-15	84.2190	25	10.000	65	1.96532	105	0.54448
-14	79.3110	26	9.55074	66	1.89627	106	0.52912
-13	74.5360	27	9.12445	67	1.83003	107	0.51426
-12	70.1698	28	8.71983	68	1.76647	108	0.49989
-11	66.0898	29	8.33566	69	1.70547	109	0.48600
-10	62.2756	30	7.97078	70	1.64691	110	0.47256
-9	58.7079	31	7.62411	71	1.59068	111	0.45957
-8	56.3694	32	7.29464	72	1.53668	112	0.44699
-7	52.2438	33	6.98142	73	1.48481	113	0.43482
-6	49.3161	34	6.68355	74	1.43498	114	0.42304
-5	46.5725	35	6.40021	75	1.38703	115	0.41164
-4	44.0000	36	6.13059	76	1.34105	116	0.40060
-3	41.5878	37	5.87359	77	1.29078	117	0.38991
-2	39.8239	38	5.62961	78	1.25423	118	0.37956
-1	37.1988	39	5.39689	79	1.21330	119	0.36954
0	35.2024	40	5.17519	80	1.17393	120	0.35982
1	33.3269	41	4.96392	81	1.13604	121	0.35042
2	31.5635	42	4.76253	82	1.09958	122	0.3413
3	29.9058	43	4.57050	83	1.06448	123	0.33246
4	28.3459	44	4.38736	84	1.03069	124	0.32390
5	26.8778	45	4.21263	85	0.99815	125	0.31559
6	25.4954	46	4.04589	86	0.96681	126	0.30754
7	24.1932	47	3.88673	87	0.93662	127	0.29974
8	22.5662	48	3.73476	88	0.90753	128	0.29216
9	21.8094	49	3.58962	89	0.87950	129	0.28482
10	20.7184	50	3.45097	90	0.85248	130	0.27770
11	19.6891	51	3.31847	91	0.82643	131	0.27078
12	18.7177	52	3.19183	92	0.80132	132	0.26408
13	17.8005	53	3.07075	93	0.77709	133	0.25757
14	16.9341	54	2.95896	94	0.75373	134	0.25125
15	16.1156	55	2.84421	95	0.73119	135	0.24512
16	15.3418	56	2.73823	96	0.70944	136	0.23916
17	14.6181	57	2.63682	97	0.68844	137	0.23338
18	13.9180	58	2.53973	98	0.66818	138	0.22776
19	13.2631	59	2.44677	99	0.64862	139	0.22231

Appendix 2

		Unit: °C---K	Discharge temp. sensor table				
-20	542.7	20	68.66	60	13.59	100	3.702
-19	511.9	21	65.62	61	13.11	101	3.595
-18	483	22	62.73	62	12.65	102	3.492
-17	455.9	23	59.98	63	12.21	103	3.392
-16	430.5	24	57.37	64	11.79	104	3.296
-15	406.7	25	54.89	65	11.38	105	3.203
-14	384.3	26	52.53	66	10.99	106	3.113
-13	363.3	27	50.28	67	10.61	107	3.025
-12	343.6	28	48.14	68	10.25	108	2.941
-11	325.1	29	46.11	69	9.902	109	2.86
-10	307.7	30	44.17	70	9.569	110	2.781
-9	291.3	31	42.33	71	9.248	111	2.704
-8	275.9	32	40.57	72	8.94	112	2.63
-7	261.4	33	38.89	73	8.643	113	2.559
-6	247.8	34	37.3	74	8.358	114	2.489
-5	234.9	35	35.78	75	8.084	115	2.422
-4	222.8	36	34.32	76	7.82	116	2.357
-3	211.4	37	32.94	77	7.566	117	2.294
-2	200.7	38	31.62	78	7.321	118	2.233
-1	190.5	39	30.36	79	7.086	119	2.174
0	180.9	40	29.15	80	6.859	120	2.117
1	171.9	41	28	81	6.641	121	2.061
2	163.3	42	26.9	82	6.43	122	2.007
3	155.2	43	25.86	83	6.228	123	1.955
4	147.6	44	24.85	84	6.033	124	1.905
5	140.4	45	23.89	85	5.844	125	1.856
6	133.5	46	22.89	86	5.663	126	1.808
7	127.1	47	22.1	87	5.488	127	1.762
8	121	48	21.26	88	5.32	128	1.717
9	115.2	49	20.46	89	5.157	129	1.674
10	109.8	50	19.69	90	5	130	1.632
11	104.6	51	18.96	91	4.849		
12	99.69	52	18.26	92	4.703		
13	95.05	53	17.58	93	4.562		
14	90.66	54	16.94	94	4.426		
15	86.49	55	16.32	95	4.294	B(25/50)=3950K	
16	82.54	56	15.73	96	4.167		
17	78.79	57	15.16	97	4.045	R(90°C)=5KΩ±3%	
18	75.24	58	14.62	98	3.927		
19	71.86	59	14.09	99	3.812		

**Appendix 3:**

°C	10	11	12	13	14	15	16	17	18	19	20	21	22
°F	48	50	52	54	56	58	60	62	64	66	68	70	72
°C	23	24	25	26	27	28	29	30	31	32	33	34	35
°F	74	76	78	80	82	84	86	88	90	92	94	96	98

**2. Compressor check**

Measure the resistance value of each winding by using the tester.

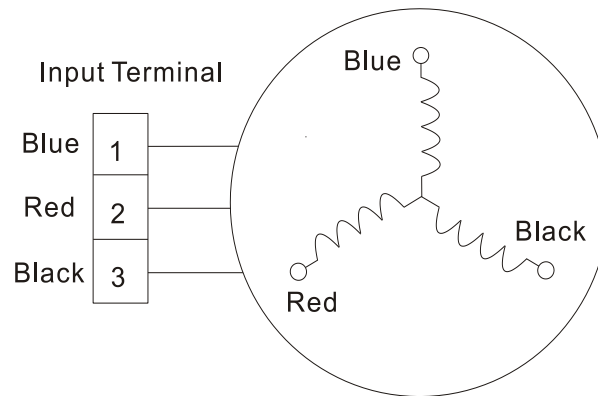

Position	Resistance Value						
	ATM150D23UFZ	ATF235D22UMT	ATF250D22UMT	ATF310D43UMT	ATQ360D1UMU	ATQ420D1UMU	EAPQ420D1UMUA
Blue - Red	1.72 Ω	0.75 Ω	0.75 Ω	0.65 Ω	0.37 Ω	0.38Ω	0.1Ω
Blue - Black							
Red - Blue							



### 3. IPM continuity check

Turn off the power, let the large capacity electrolytic capacitors discharge completely, and dismount the IPM. Use a digital tester to measure the resistance between P and UVWN; UVW and N.

Digital tester		Normal resistance value	Digital tester		Normal resistance value
(+)Red	(-)Black		(+)Red	(-)Black	
P	N	∞ (Several MΩ)	U	N	∞ (Several MΩ)
	U		V		
	V		W		
	W		(+)Red		

### 4. AC Fan Motor.

Measure the resistance value of each winding by using the tester.

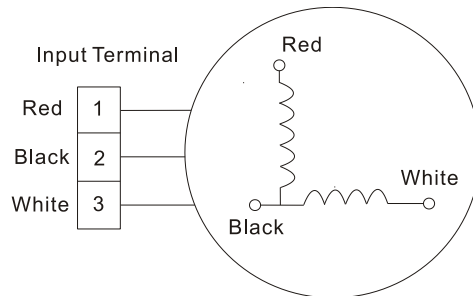

Position	Resistance Value			
	RPG20B		RPG28H	
Black - Red	381Ω±8% (20°C) (Brand: Weiling)	342Ω±8% (20°C) (Brand: Dayang)	183.6Ω±8% (20°C) (Brand: Weiling)	180Ω±8% (20°C) (Brand: Wolong)
White - Black	267Ω±8% (20°C) (Brand: Weiling)	253Ω±8% (20°C) (Brand: Dayang)	206Ω±8% (20°C) (Brand: Weiling)	190Ω±8% (20°C) (Brand: Wolong)

Measure the resistance value of each winding by using the tester.

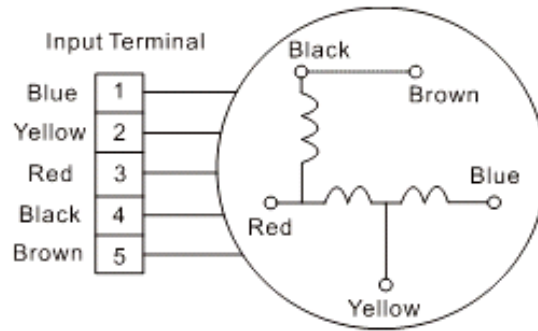

Position	Resistance Value						
	YDK70-6FB	YDK180-8GB	YSK27-4G	YSK68-4B	YDK45-6B	YSK25-6L	YDK53-6FB(B)
Black - Red	56Ω±8% (20°C)	24.5Ω±8% (20°C)	317Ω±8% (20°C)	145Ω±8% (20°C)	345Ω±8% (20°C)	627Ω±8% (20°C)	88.5Ω±8% (20°C)
Red - Yellow	76Ω±8% (20°C)	19Ω±8% (20°C)	252Ω±8% (20°C)	88Ω±8% (20°C)	150Ω±8% (20°C)	374.3Ω±8% (20°C)	138Ω±8% (20°C)
Yellow - Blue	76Ω±8% (20°C)	19Ω±8% (20°C)	252Ω±8% (20°C)	88Ω±8% (20°C)	150Ω±8% (20°C)	374.3Ω±8% (20°C)	138Ω±8% (20°C)

#### 5.4-way valve

1. Power on, use a digital tester to measure the voltage, when the unit operates in cooling, it is 0V. When the unit operates in heating, it is about 230VAC.

If the value of the voltage is not in the range, the PCB must have problems and need to be replaced.



2 Turn off the power, use a digital tester to measure the resistance. The value should be 1.8~2.5 K $\Omega$ .



## 6.EXV check

Disconnect the connectors.

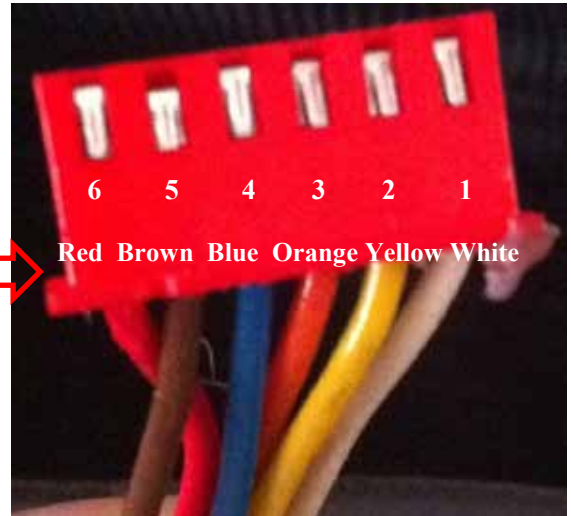
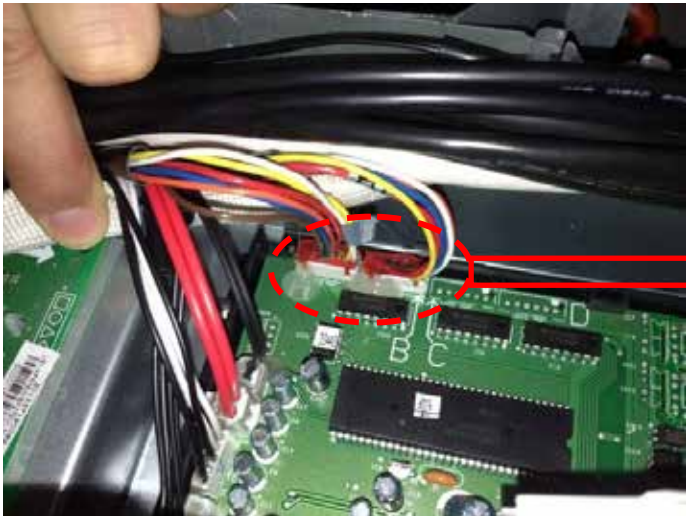
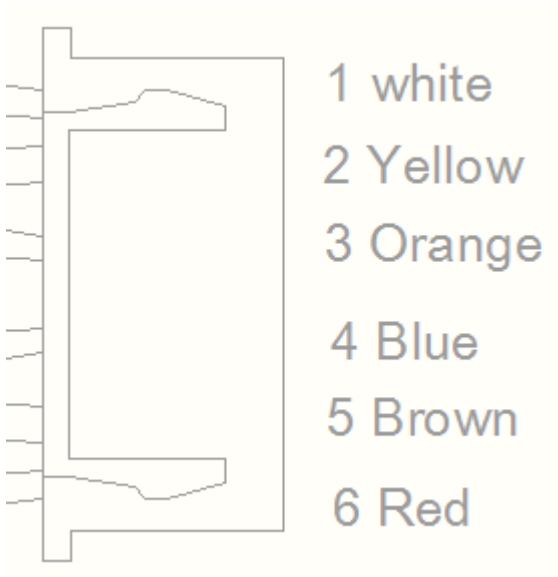

**Resistance to EXV coil**

Color of lead wire	Normal Value
Red- Blue	About 50Ω
Red - Yellow	
Brown-Orange	
Brown-White	

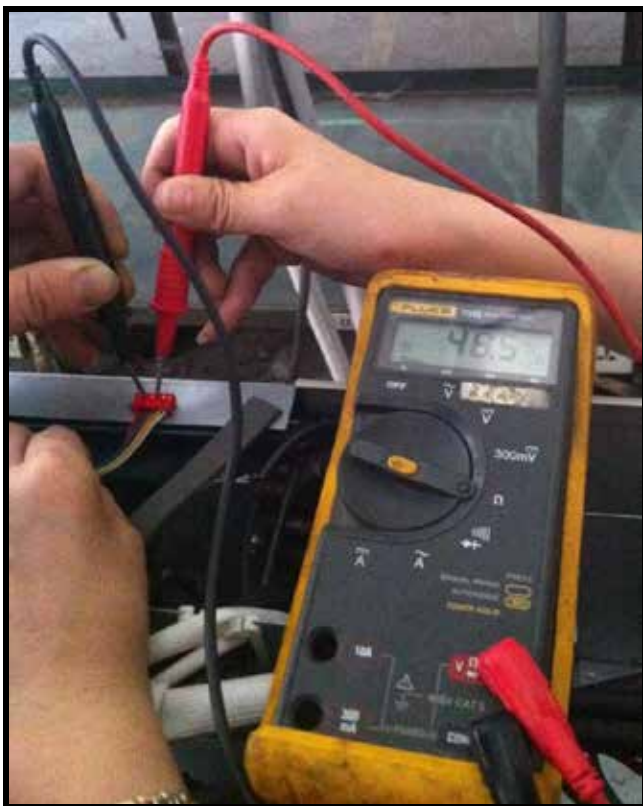
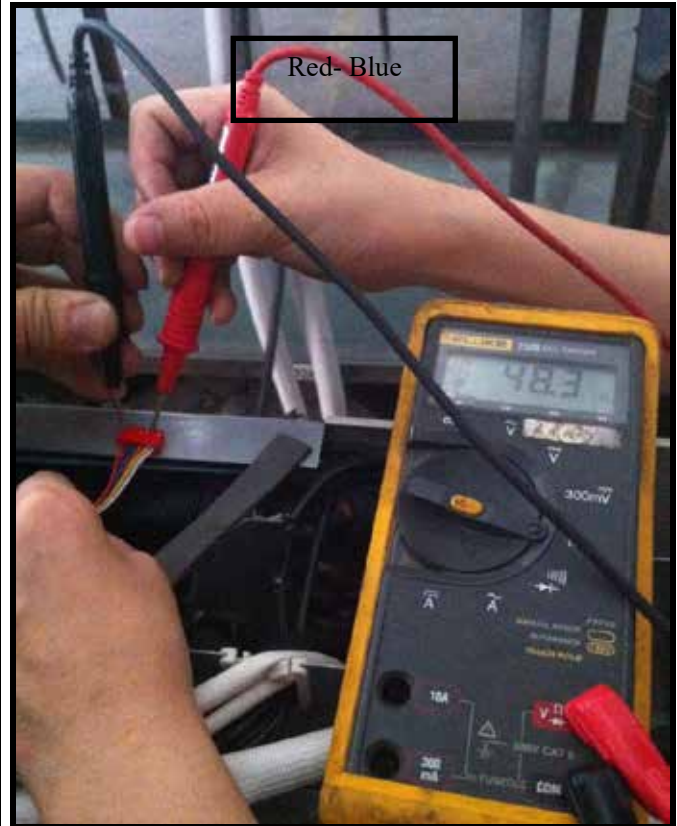
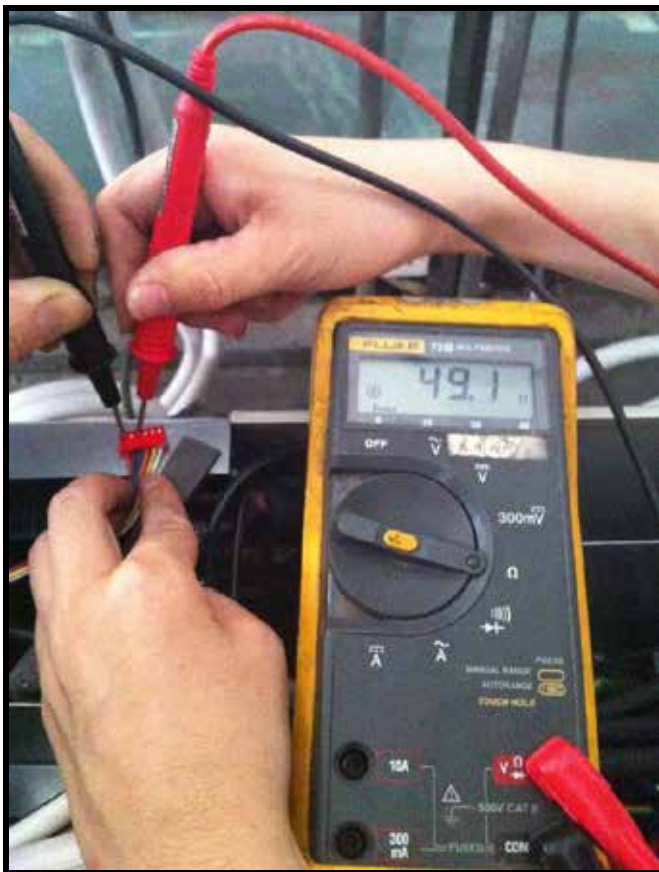

Brown-Orange  
Red - Yellow

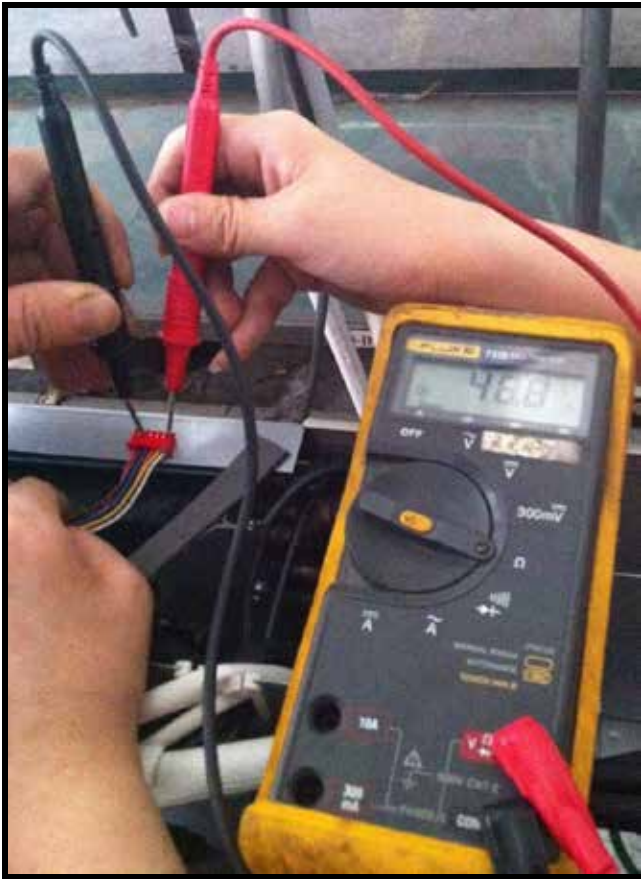



Brown-White

## 8. Disassembly Instructions

**Note:** This part is for reference, the photos may have slight difference with your machine.

➤ **18DV-1, 28TV-1 (WD30 metal plate)**

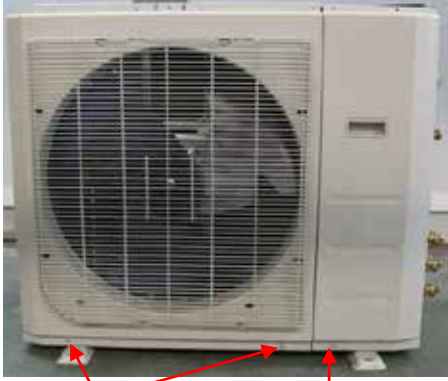
No.	Part name	Procedures	Remarks
1	Panel plate	<p>How to remove the panel plate.</p> <p>7) Turn off the air conditioner. Turn off the power breaker.</p> <p>8) Remove the screws of big handle, and remove the big handle.(4 screws)</p> <p>9) Remove the screws of top cover, and remove the top cover. (4 screws)</p> <p>10) Remove the screws of right front side panel, and remove the right front side panel (1 screws)</p> <p>11) Remove the screws of front panel, and remove the front panel. (8 screws)</p>	<p>Screws of big handle      Screws of top cover</p>  <p>Screws of top cover</p>  <p>Screws of front panel      Screws of right front side panel</p> 

12) Remove two screws of terminal board, screws of water collector and fifteen screws of right-rear panel, and remove the right-rear panel.

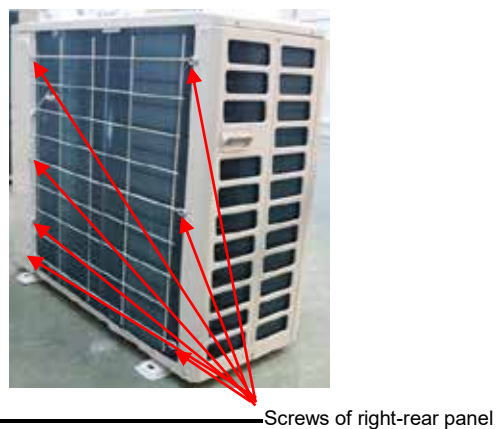
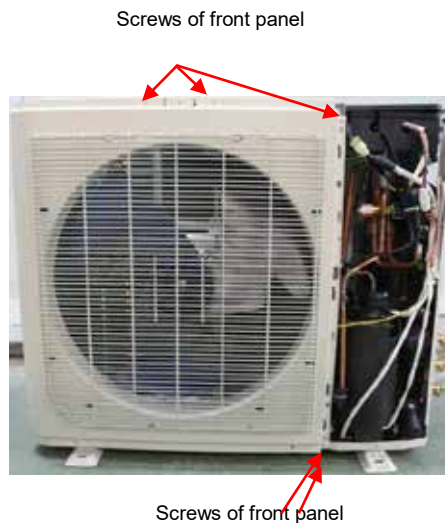
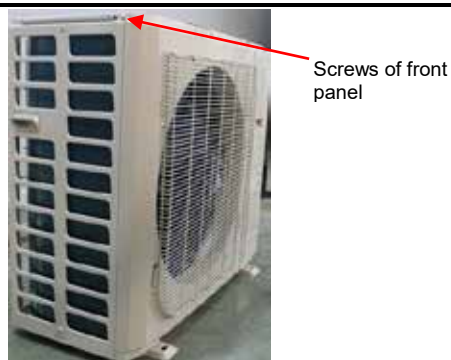

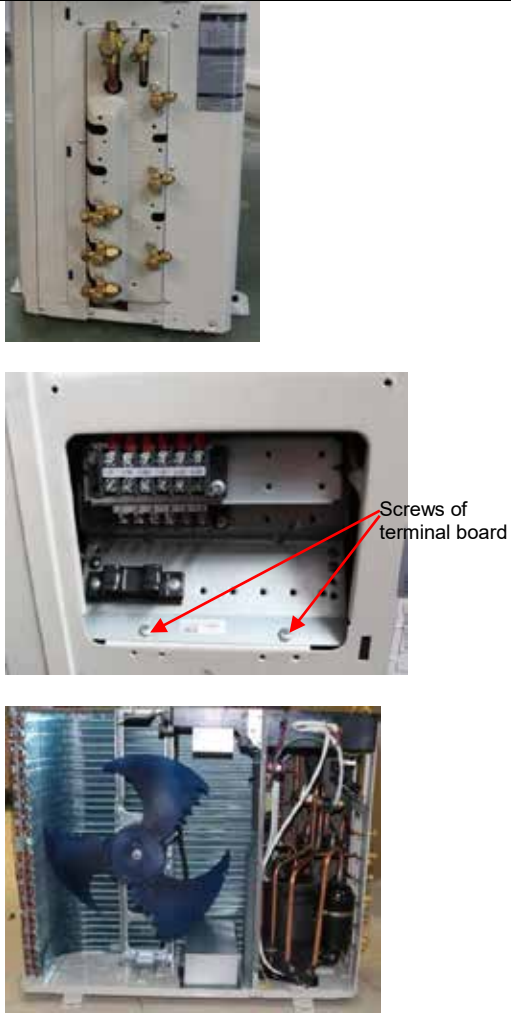
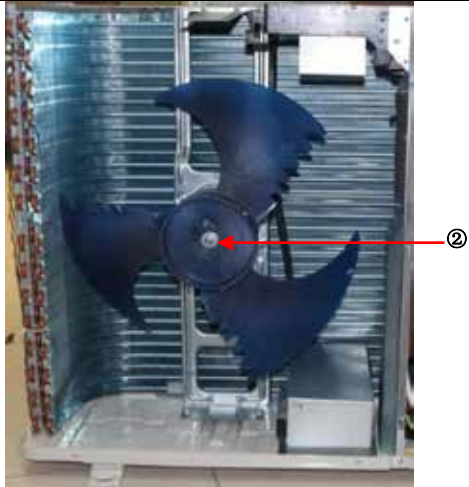
			
2	Fan assembly	<p>How to remove the fan assembly.</p> <p>5) Remove the top cover, right front side panel and front panel from item 1.step 1~4</p> <p>6) Remove the hex nut fixing the fan.</p> <p>7) Remove the fan.</p>	

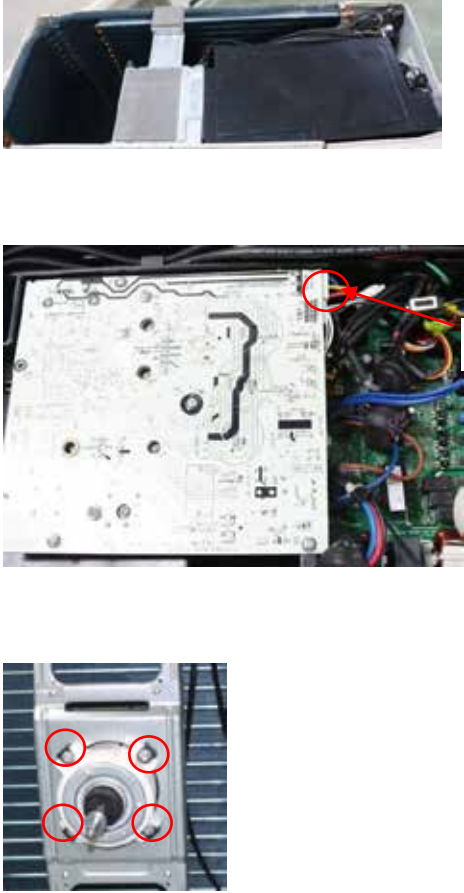
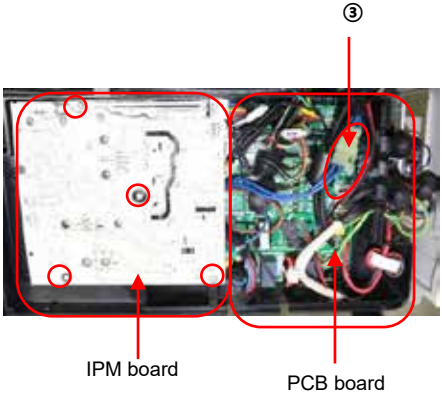
		<p>8) Remove the cover of electrical control box cover.</p> <p>9) Disconnect the fan motor connector CN14(5p,white) from the IPM board.</p> <p>10) Remove the fan motor after unfastening four fixing screws.</p>	
<p>3</p>	<p>Electrical parts</p>	<p>How to remove the electrical parts.</p> <p>10) Perform work of item 1,2.</p> <p>11) Remove the four screws fixing the IPM board.</p> <p>12) Unfasten the connector of the reactor.</p> <p>13) Unfasten the connector of the compressor.</p> <p>14) Disconnect following 3</p>	 <p>IPM board</p> <p>PCB board</p>

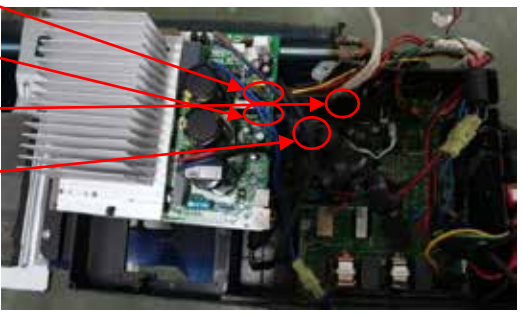
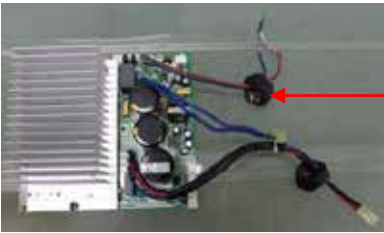
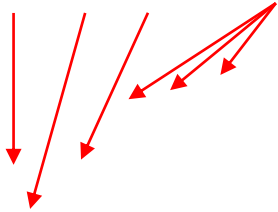
	<p>pieces of connection wires and connectors between IPM and PCB.</p> <p>CN1(5p,white)                  CN14(3p,white)                  CN3(red or brown)                  CN5(blue)</p> <p>15) Remove the IPM board.</p> <p>16) Disconnect the connectors and wires connected from PCB and other parts.</p> <p>Connectors:</p> <p>CN17:T3/T4 temperature sensor (2p/2p,white)                  CN7: Discharge temperature sensor (2p,white)                  CN15:T2B-A,B,C temperature sensor (2p/2p/2p,white)                  CN18/CN19/CN22: Electronic</p>	   <p>CN17 CN15 CN7 CN18/CN19/CN22</p> 
--	--	--

expansion valve A,B,C  
(6p/6p/6p,red/red/red)

CN25/CN23/CN20: S-A,S-B,S-C  
(3p/3p/3p,white/white/white)

Wires:

CN1/CN2: 4-way valve (blue-blue)

CN5/CN6: Crankcase heating cable  
(red-red)



CN3:L1-IN (red)

CN4:L2-IN (black)

17) Disconnect the  
grounding wire (yellow-green)  
after removing the big handle  
and the right-rear panel.

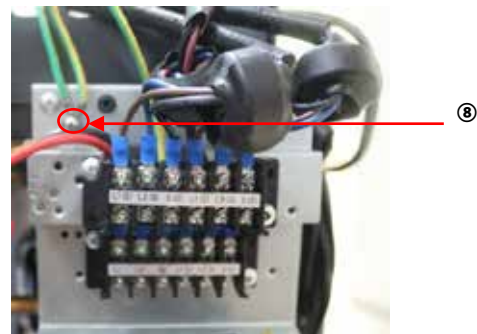
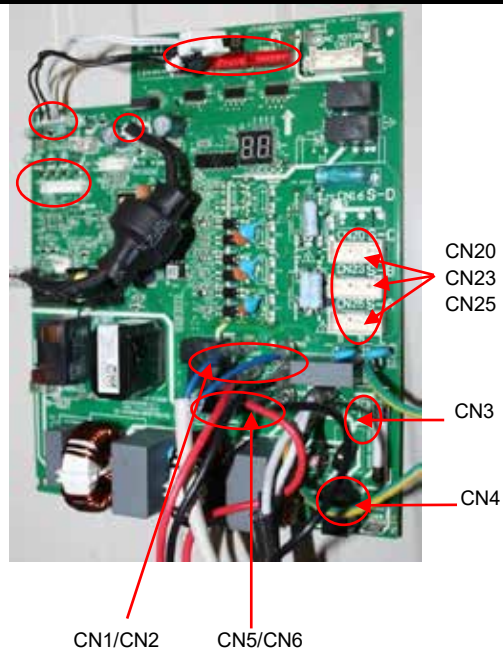
18) Remove the PCB board.



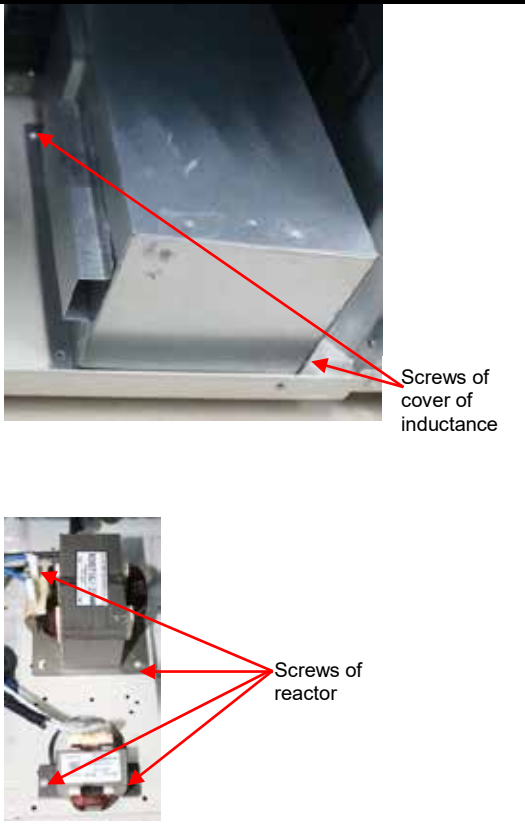
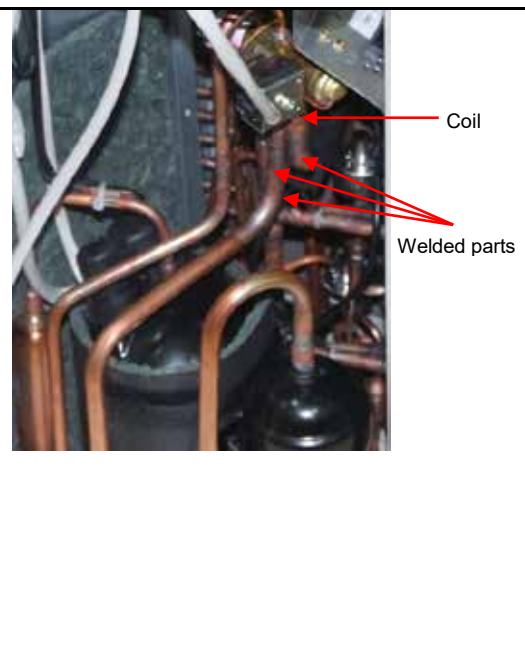

4	Compressor	<p>How to remove the compressor.</p> <p>9) Perform work of item 1,2,3.</p> <p>10) Remove the electrical control box and partition plate.</p> <p>11) Extract refrigerant gas.</p> <p>12) Remove the sound insulation material and crankcase heating cable.</p> <p>13) Remove terminal cover of compressor, and disconnect wires of compressor thermo and compressor from the terminal.</p> <p>14) Remove the discharge pipe and suction pipe with a burner.</p> <p>15) Remove the hex nuts and washers fixing the compressor to bottom plate.</p> <p>16) Lift the compressor.</p>	 
---	------------	--	---

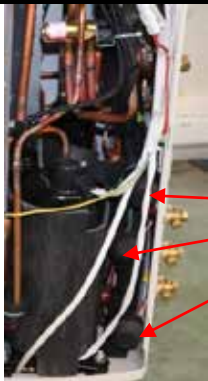
<p>5</p>	<p>Reactor</p>	<p>How to remove the reactor</p> <ol style="list-style-type: none"> <li>1) Perform work of item 1,2</li> <li>2) Unfasten the connector between IPM and reactor.</li> <li>3) Remove two screws of cover of inductance, and remove the cover of inductance</li> <li>4) Disconnect two pieces of wires connected from the cover of inductance.</li> <li>5) Remove four screws of reactor, and remove the reactor.</li> </ol>	
<p>6</p>	<p>The 4-way valve</p>	<p>How to remove the 4-way valve</p> <ol style="list-style-type: none"> <li>6) Perform work of item 1,2.</li> <li>7) Extract refrigerant gas.</li> <li>8) Remove the electrical parts from item 3.</li> <li>9) Remove fixing screw of the coil, and remove the coil.</li> <li>10) Detach the welded parts of 4-way valve and pipe.</li> </ol>	

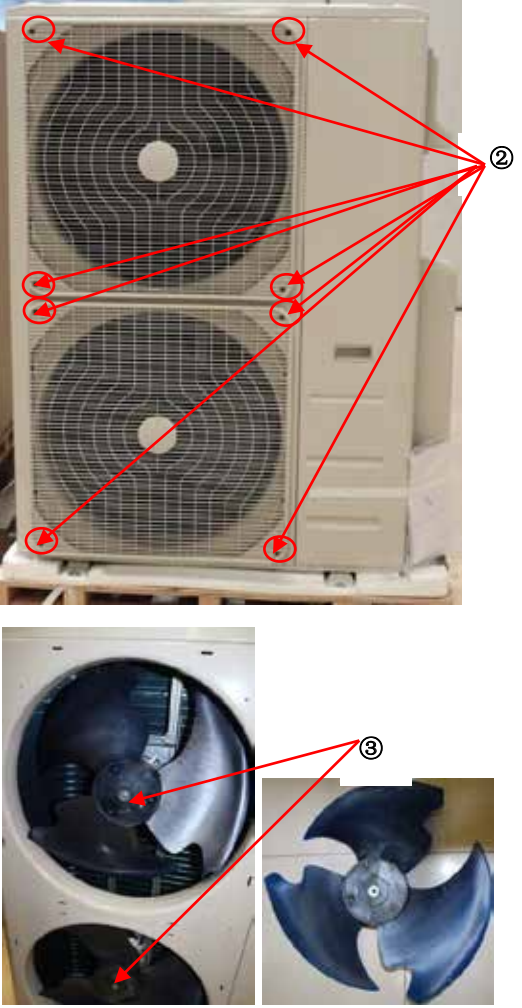

7	The expansion valve	<p>How to remove the expansion valve</p> <p>5) Perform work of item 1,2.</p> <p>6) Remove the electrical parts from item 3.</p> <p>7) Remove the coils.</p> <p>8) Detach the welded parts of expansion valves and pipes.</p>	 <p>Expansion valves</p>
---	---------------------	--	--

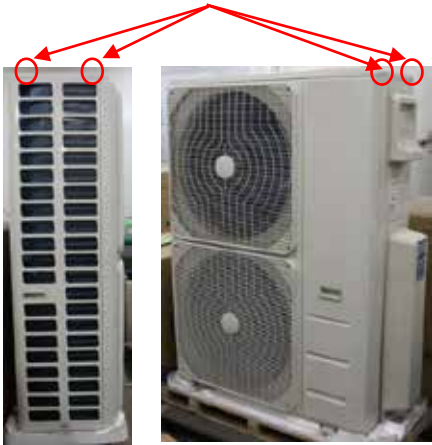

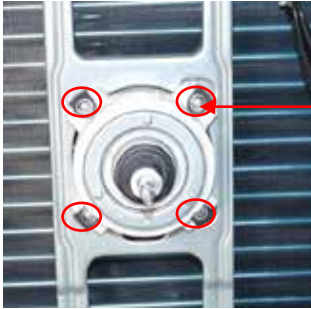

➤ 36QV-1, 48PV-1 (WE30 metal plate)

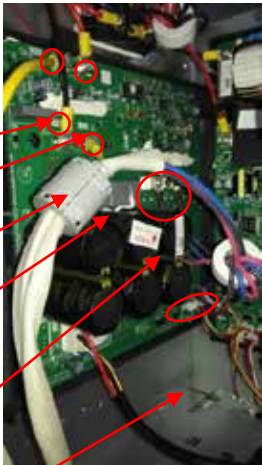
No	Part name	Procedures	Remarks
1	Fan assembly	<p>How to remove the fan assembly.</p> <ol style="list-style-type: none"> <li>1) Turn off the air conditioner. Turn off the power breaker.</li> <li>2) Remove the screws of air outlet grille(8 screws)</li> <li>3) Remove the hex nut fixing the fan.</li> <li>4) Remove the fan.</li> </ol>	

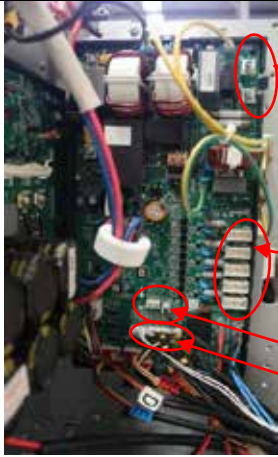

		<p>5) Remove the screws of top cover, and remove the top cover. (4 screws)</p> <p>6) Remove the screws of front side panel, and remove the front side panel (1 screw)</p> <p>7) Disconnect the fan motor connectors FAN1(3p,white) and FAN2(3p,white) from DC motor driver board.</p> <p>8) Remove the fan motor after unfastening fixing screws.</p>	<p>Screws of top</p>     <p>⑥</p> <p>⑦</p> <p>⑧</p>
--	--	---	--

<p>2</p>	<p>Panel plate</p>	<p>How to remove the panel plate.</p> <p>4) Remove big handle.(2 screws) and water collector(2 screws)</p> <p>5) Remove 2 screws of terminal board and 15 screws of right-rear panel, and remove the right-rear panel.</p>	<p>Screws of big handle</p> <p>Screws of Water collector</p> <p>Screws of terminal board</p> <p>Screws of right-rear panel</p> <p>Screws of right-rear panel</p>
<p>3</p>	<p>Electrical parts</p>	<p>How to remove the electrical parts.</p> <p>1) Perform work of item 1 step 5~6 and item 2.</p>	<p>IPM board</p> <p>PCB board</p> <p>DC Fan Driver board</p>

		<p>2) Disconnect the fan motor Connector(5p,white) from the IPM board.</p> <p>3) Disconnect following 8 pieces of connection wires and connectors between IPM and other parts.</p> <p>CN2(yellow)</p> <p>CN1(red)</p> <p>CN6(black)</p> <p>CN3(yellow)</p> <p>U、V、W(black)</p> <p>CN9(10p,white)</p> <p>4) Remove the fixing screws then remove the IPM board.</p> <p>5) Disconnect the connectors and wires connected from PCB and other parts.</p> <p>Connectors:</p>	  
--	--	--	---

		<p>CN8: Discharge temperature sensor (2p,white)</p> <p>CN12: Heatsink temperature sensor(2p,red)</p> <p>CN9:T3/T4 temperature sensor (2p/2p,white)</p> <p>CN11:T2B-A,B,C,D,E temperature sensor (2p/2p/2p/2p/2p,white)</p> <p>CN15/CN23/CN26/CN30/CN33: Electronic expansion valve (6p/6p/6p/6p/6p,red)</p> <p>CN37/CN29/CN21/CN16/CN13: S-A,S-B,S-C,S-D,S-E (3p/3p/3p/3p/3p,white)</p> <p>CN10: High and low pressure switch (2p/2p, white)</p> <p><b>Wires:</b></p> <p>CN17/CN18: 4-way valve (blue-blue)</p> <p>CN19/CN20: connected to crankcase heating cable. (black-red)</p> <p>CN24/CN25: Electric heater of chassis (orange-orange)</p> <p>CN1:L-IN (red)</p> <p>CN3:N-IN (black)</p> <p>6) Disconnect the grounding wire (yellow-green) after removing the big handle.</p> <p>7) Remove the PCB board.</p>	 <p>CN3 CN1</p> <p>CN13 CN16 CN21 CN29 CN37</p> <p>CN8 CN12 CN9 CN11</p>  <p>CN10</p> <p>CN30/CN23/CN33/CN26/CN15</p>  <p>CN17/CN18 CN19/CN20 CN24/CN25</p>  <p>⑥</p> 
--	--	--	---

<p>4</p>	<p>Compressor</p>	<p>How to remove the compressor.</p> <ol style="list-style-type: none"> <li>1) Perform work of item 1 step 5~6 and item 2..</li> <li>2) Extract refrigerant gas.</li> <li>3) Remove the sound insulation material and crankcase heating cable.</li> <li>4) Remove terminal cover of compressor, and disconnect wires of crankcase electric heater and compressor from the terminal.</li> <li>5) Remove the discharge pipe and suction pipe with a burner.</li> <li>6) Remove the hex nuts and washers fixing the compressor to bottom plate.</li> <li>7) Lift the compressor.</li> </ol>	 <p>The top photograph shows the compressor unit with its associated copper piping. A red arrow points to a specific pipe, labeled with a circled number 5. The bottom photograph shows the compressor being lifted from its mounting. Red circles highlight the hex nuts and washers that were used to secure the compressor to the bottom plate, labeled with a circled number 6.</p>
----------	-------------------	--	--

<p>5</p>	<p>The 4-way valve</p>	<p>How to remove the 4-way valve</p> <p>6) Perform work of item 1 step 5~6 and item 2..</p> <p>7) Extract refrigerant gas.</p> <p>8) Remove the electrical parts from item 3.</p> <p>9) Remove fixing screw of the coil, and remove the coil.</p> <p>10) Detach the welded parts of 4-way valve and pipe.</p>	 <p>Coil</p> <p>Welded parts</p>
<p>6</p>	<p>The expansion valve</p>	<p>How to remove the expansion valve</p> <p>5) Perform work of item 1,2.</p> <p>6) Remove the electrical parts from item 3..</p> <p>7) Remove the coil.</p> <p>8) Detach the welded parts of expansion valves and pipes.</p>	 <p>Expansion valves</p>

**PAGE INTENTIONALLY  
LEFT BLANK**

---

Due to ongoing product improvements, specifications and dimensions are subject to change and correction without notice or incurring obligations. Determining the application and suitability for use of any product is the responsibility of the installer. Additionally, the installer is responsible for verifying dimensional data on the actual product prior to beginning any installation preparations.

Incentive and rebate programs have precise requirements as to product performance and certification. All products meet applicable regulations in effect on date of manufacture; however, certifications are not necessarily granted for the life of a product. Therefore, it is the responsibility of the applicant to determine whether a specific model qualifies for these incentive/rebate programs.

*Comfort-Cire*<sup>®</sup> **Century**